

STATE OF NORTH CAROLINA
DEPARTMENT OF TRANSPORTATION

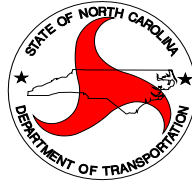

REQUEST FOR PROPOSAL

DATE AND TIME OF BID OPENING: MARCH 12, 2025 AT 2:00 P.M.

BID PROPOSAL NO.: 54-SH-05-PR18939

WBS ELEMENT NOS.: VARIOUS

COUNTIES: WAKE AND FRANKLIN – DIVISION 5

**LOCATION: VARIOUS INTERSTATE, PRIMARY AND SECONDARY
ROADS**

**TYPE OF WORK: LITTER/DEBRIS REMOVAL AND RECYCLING, UPON
REQUEST**

DATE OF AVAILABILITY: MAY 1, 2025 OR UPON ISSUANCE OF A PURCHASE ORDER

COMPLETION DATE: APRIL 30, 2026

PRE-QUALIFICATION MANDATORY

PROPOSAL
FOR THE CONSTRUCTION OF
BID NO. 54-SH-05-PR18939 IN WAKE AND FRANKLIN COUNTIES – DIVISION 5,
NORTH CAROLINA
FEBRUARY 19, 2025
DEPARTMENT OF TRANSPORTATION,
RALEIGH, NORTH CAROLINA

The Bidder has carefully examined the location of the proposed work to be known as **BID NO 54-SH-05-PR18939**; has carefully examined the plans and specifications, which are acknowledged to be part of the proposal, the special provisions, the proposal, the form of contract; and thoroughly understands the stipulations, requirements and provisions. The undersigned bidder agrees to bound upon his execution of the bid and subsequent award to him by the Department of Transportation in accordance with this proposal. The undersigned Bidder further agrees to provide all necessary machinery, tools, labor, and other means of construction; and to do all the work and to furnish all materials, except as otherwise noted, necessary to perform and complete the said contract in accordance with *the 2024 Standard Specifications for Roads and Structures* by the dates(s) specified in the Project Special Provisions and in accordance with the requirements of the Engineer, and at the unit or lump sum prices, as the case may be, for the various items given on the sheets contained herein.

The Bidder shall provide and furnish all the materials, machinery, implements, appliances and tools, and perform the work and required labor to construct and complete State Highway **BID NO. 54-SH-05-PR18939**, for the unit or lump sum prices, as the case may be, bid by the Bidder in his bid and according to the proposal, plans, and specifications prepared by said Department, which proposal, plans, and specifications show the details covering this project, and hereby become a part of this contract.

The published volume entitled *North Carolina Department of Transportation, Raleigh, Standard Specifications for Roads and Structures, January 2024* with all amendments and supplements thereto, is by reference incorporated into and made a part of this contract; that, except as herein modified, all the construction and work included in this contract is to be done in accordance with the specifications contained in said volume, and amendments and supplements thereto, under the direction of the Engineer.

If the proposal is accepted and the award is made, the contract is valid only when signed either by the Contract Officer or such other person as may be designated by the Secretary to sign for the Department of Transportation. The conditions and provisions herein cannot be changed except over the signature of the said Contract Officer or Division Engineer.

The quantities shown in the itemized proposal for the project are considered to be approximate only and are given as the basis for comparison of bids. The Department of Transportation may increase or decrease the quantity of any item or portion of the work as may be deemed necessary or expedient.

An increase or decrease in the quantity of an item will not be regarded as sufficient ground for an increase or decrease in the unit prices, nor in the time allowed for the completion of the work, except as provided for the contract.

TABLE OF CONTENTS

PROJECT SPECIAL PROVISIONS - GENERAL	PAGE NO.
General	5
Pre-Qualification	5
Traffic Control Pre-Qualification	6
General Contractors Licensing Requirements	6
Bidding	6
Contract Time for ID/IQ	6
Non-Exclusive Contract	7
Award of Contract	7
Basis of Award	7
Quantities Estimated	7
Bond Requirements	8
Intermediate Contract Time Number 1 and Liquidated Damages	8
Intermediate Contract Time Number 2 and Liquidated Damages	8
Progress and Prosecution	9
Traffic Control and Work Zone Safety	9
Safety Vests	10
Supervision by Contractor	10
Insurance	11
Responsibility for Damage Claims	11
Payment and Retainage	11
PROJECT SPECIAL PROVISIONS – ID/IQ	PAGE NO.
Multi-Year Maintenance Contracts ID/IQ	13
Work Order Assignment	13
Mobilization and Liquidated Damages	13
Renewal of Contract	14
Dispute Resolution Process for ID/IQ	14
PROJECT SPECIAL PROVISIONS - ROADWAY	PAGE NO.
Litter/Debris Removal and Recycling	15
Reporting	17
Hazardous, Contaminated, and/or Toxic Material	17
Notification of Work	17
Mobilization	17
Safety	17
Equipment Requirements	18
Equipment Idling Guidelines	18
Bid Items	19
Quality, Inspection and Basis of Acceptance	20
Method of Measurement	20
Basis of Payment	20
Minority Business Enterprise and Women Business Enterprise	21
STANDARD SPECIAL PROVISIONS	PAGE NO.
Availability of Funds – Termination of Contracts	33
Authority of the Engineer	33
Minimum Wages	33
Erosion Control	34

Work Zone Signing	34
Plant and Pest Quarantines	34
Bankruptcy	35
Subletting of Contract	35
Debarment Statement	35
Default of Contract	35
Cooperation between Contractors	35
No Major Contract Items	35
No Specialty Items	35
Utility Conflicts	35
Driveways and Private Property	36
Outsourcing Outside the USA	36
Title VI and Nondiscrimination	36

APPENDIX	PAGE NO.
Work Zone Guidance for Litter/Debris Removal	44
General	44
Exceptions	45
Work Zone Signing	45
Sign Detail	46
Service Vehicles	47
Typical Sections	48
Operations Diagrams	49

INSTRUCTIONS TO BIDDERS	PAGE NO.
Preparation and Submission of Traditional Paper Bids	57
Opening of Bids	58

BID SUBMITTAL PACKAGE	PAGE NO.
Cover Sheet	1
Contract Bid Form	2
Contractor Information	3
Federal Employer Identification Number	4
Listing of MBE/WBE Subcontractors	5
Contractor's Work Experience and References	6
Execution of Bid Non-Collusion, Debarment and Gift Ban Certification	7
Bid Submittal Package Checklist	15

PROJECT SPECIAL PROVISIONS - GENERAL

GENERAL

This contract is for litter/debris removal and recycling, upon request, on interstate, primary, and secondary roads and their interchanges in Wake and Franklin Counties in Division Five. The notification shall be for a minimum of one half shoulder mile (may consist of more than one route within a county) of litter/debris collection with the following exceptions. Isolated Dump Sites may be required to be picked up separately outside of the notified pickup area(s). Isolated Bulk Items shall be required to be picked up separately outside of the notified pickup area(s). The Contractor is to provide all equipment, labor and material.

All materials and workmanship shall be in accordance with the following:

The Project Special Provisions, Project Standard Provisions, most current Standard Special Provisions, *Manual of Uniform Traffic Control Devices (MUTCD)*, Provisions contained in the applicable Sections of the North Carolina Department of Transportation's *Standard Specifications for Roads and Structures* and Drawings contained in the applicable sections of the North Carolina Department of Transportation's *Roadway Standard Drawings* shall apply.

The published volume entitled *North Carolina Department of Transportation, Standard Specifications for Roads and Structures*, with all amendments and supplements thereto, is by reference incorporated into and made a part of this contract; that, except as herein modified, all the construction and work included in the contract is to be done in accordance with the specifications contained in said volume, and amendments and supplements thereto, under the direction of the Engineer.

The Contractor shall keep himself fully informed of all Federal, State, and local laws, ordinances, and regulations, and shall comply with the provisions of Section 107 of the *Standard Specifications*.

INTERESTED PARTIES LIST NOT REQUIRED:

(6-21-22)(Rev. 2-20-24)

102

SP1 G02

Revise the *Standard Specifications* as follows:

The *Interested Parties List* sign up process is not applicable to this contract.

Page 1-13, Article 102-3 PROPOSALS AND INTERESTED PARTIES LIST, lines 12-15, delete the first paragraph.

Page 1-14, Article 102-8 PREPARATION AND SUBMISSION OF BIDS, lines 43-44, delete the first sentence of the first paragraph.

PRE-QUALIFICATION

Firms that wish to bid on this project as the prime contractor must be pre-qualified as either "Bidder" or "Purchase Order Contract (POC) Prime Contractor" prior to submitting the bid.

Information regarding the requirements to become pre-qualified as a Bidder or POC Contractor, including the application to become pre-qualified if not already pre-qualified, can be found at the following website: <https://connect.ncdot.gov/business/Prequal/Pages/default.aspx>.

If unsure as to whether a firm is currently pre-qualified by NCDOT through Contractual Services Management, search the Directory of Transportation Firms at the following website: <https://www.ebs.nc.gov/VendorDirectory/>. Bids received from firms that are not pre-qualified as a Bidder or POC Prime Contractor through NCDOT Contractual Services Management will not be opened.

Bidders must renew their pre-qualification or re-qualify each year. It is the bidder's responsibility to ensure that their existing pre-qualification status does not lapse prior to bid opening (or beginning work as a subcontractor). **Advance notification of pending renewal dates is not guaranteed.**

TRAFFIC CONTROL PRE-QUALIFICATION

The Contractor performing the Work Zone Traffic Control (either as the prime contractor or as a subcontractor) will be required to be prequalified for the NCDOT Work Code "001105 Work Zone Traffic Control Devices".

Note: The Contractor performing Work Zone Traffic Control shall have a minimum of one (1) NCDOT Certified Work Zone Supervisor. In order to become a Certified Work Zone Supervisor see information found at: <https://connect.ncdot.gov/projects/WZTC/Pages/Training.aspx>. At no time during the contract is the Contractor to be without a NCDOT Certified Work Zone Supervisor.

GENERAL CONTRACTORS LICENSING REQUIREMENTS

A General Contractors license is not required to bid or perform work on this project.

BIDDING

This contract will consist of seven (7) bid items:

1. Litter/Debris Removal and Recycling on Interstate Highways per **Shoulder Mile**. This item will be measured and paid by the **Shoulder Mile**. Bidders should bid by the **Shoulder Mile**.
2. Litter/Debris Removal and Recycling on Primary Divided Highways per **Shoulder Mile**. This item will be measured and paid by the **Shoulder Mile**. Bidders should bid by the **Shoulder Mile**.
3. Litter/Debris Removal and Recycling on Primary Undivided Highways per **Shoulder Mile**. This item will be measured and paid by the **Shoulder Mile**. Bidders should bid by the **Shoulder Mile**.
4. Litter/Debris Removal and Recycling on Secondary Divided Highways per **Shoulder Mile**. This item will be measured and paid by the **Shoulder Mile**. Bidders should bid by the **Shoulder Mile**.
5. Litter/Debris Removal and Recycling on Secondary Undivided Highways per **Shoulder Mile**. This item will be measured and paid by the **Shoulder Mile**. Bidders should bid by the **Shoulder Mile**.
6. Litter/Debris Removal and Recycling at Isolated Dump Sites per **Each**. This item will be measured and paid by **Each**. Bidders should bid by **Each**.
7. Litter/Debris Removal and Recycling of Isolated Bulk Items per **Each**. This item will be measured and paid by **Each**. Bidders should bid by **Each**.

CONTRACT TIME FOR ID/IQ:

(2-15-22)

108

SP1 G11

The date of availability for this contract is **May 1, 2025**

The completion date for this contract is **April 30, 2026**

Except where otherwise provided by the contract, observation periods required by the contract will not be a part of the work to be completed by the completion date and/or intermediate contract times stated in the contract. The acceptable completion of the observation periods that extend beyond the final completion date shall be a part of the work covered by the performance and payment bonds. Work shall be accomplished in a continuous manner once the contractor begins.

Any liquidated damages for this contract will be assessed per the Mobilization and Liquidated Damages provision located elsewhere in this Contract.

NON-EXCLUSIVE CONTRACT

The Department may, as it deems to be in the best interest of the State and the Department of Transportation, execute more than one contract based on this proposal. The Contractor(s) understands and agrees, by signature on the Purchase Order Contract Bid Form, that this agreement **does not** constitute an exclusive contract. If awarded, the contracts will be executed with the lowest responsible bidders. The Department of Transportation reserves the right to make multiple awards for the services provided by this contract. Furthermore, the Department reserves the right to reject all bids received.

AWARD OF CONTRACT

(6-28-77)(Rev 2/16/2018)

Z-6

“The North Carolina Department of Transportation, in accordance with the provisions of *Title VI of the Civil Rights Act of 1964* (78 Stat. 252) and the Regulations of the Department of Transportation (*49 C.F.R., Part 21*), issued pursuant to such act, hereby notifies all bidders that it will affirmatively insure that the contract entered into pursuant to this advertisement will be awarded to the lowest responsible bidder without discrimination on the ground of race, color, or national origin”.

All eligible proposals will be evaluated and acceptance made of the bid judged in the discretion of the contracting agency to determine the lowest responsible bidder for the purpose intended. The Contracting Agency using its discretion, will determine whether a bidder is a “responsible” bidder. In determining whether a bidder is “responsible, the Contracting Agency will evaluate, the bid price, completeness and content of the bid, Bidder’s related work experience, ability of the Bidder and staff to perform the services required, Bidder’s past performance, references, and Bidder’s financial stability. After opening bids and prior to award, the Contracting Agency may also seek supporting documentation prior to determining whether a bidder is a “responsible” bidder. No changes in bid price or price negotiations will be allowed after bids are opened and prior to an award. After the Contracting Agencies evaluation, the award of the contract, if awarded, will be made to the lowest responsible bidder. The lowest responsible bidder will be notified that his bid has been accepted and that he has been awarded the contract. Withdrawal of proposal will be allowed only under limited conditions. If a Bidder is awarded a contract, he/she will be expected to perform the work. Failure to perform may result in the Bidder being held in default of contract. In the event of default, the Department may, in its discretion, contact the next lowest responsible bidder to determine whether that next lowest responsible bidder is willing and able to complete the contract at its bid price.

All awards are final and are not subject to further review. Any formal complaints concerning awards should be made in writing to the Engineer.

BASIS OF AWARD

Quantities for this work are estimated and are not guaranteed. Determination of the apparent low bidder will be made by extending the unit prices quoted on the Bid Proposal Form.

Unit prices shall reflect actual costs; unbalanced bids may be rejected per the North Carolina Department of Transportation’s *Standard Specifications for Roads and Structures*.

QUANTITIES ESTIMATED

The quantities shown on the itemized bid form are considered to be approximate only and are given as the basis for comparison of bids. For accounting purposes only a purchase order may contain quantity amounts and they SHALL NOT be construed as minimum quantities. Quantities shall be determined solely by the Department on an “as needed” basis. In the event of a conflict between any purchase orders and this proposal, this proposal shall control. An increase or decrease in quantities shall not be cause for an adjustment in unit prices.

BOND REQUIREMENTS

The provisions of Articles 102-10 and 103-7 of the Standard Specifications for Roads and Structures are waived for this project. No bonds required.

INTERMEDIATE CONTRACT TIME NUMBER 1 AND LIQUIDATED DAMAGES

The Contractor will be required to pick up the litter/debris and remove the trash bags from the specific location(s), as notified by the Department. The Contractor is required to mobilize and start litter/debris removal within seven (7) days of the notification of said location(s). The Contractor will be required to prosecute the work in a continuous and uninterrupted manner from the time they begin the work until completion of litter removal at the location. In the event that the Contractor fails to mobilize and start the litter and trash bag removal within seven (7) days, liquidated damages will be assessed. In the event that the Contractor does not prosecute the work in a continuous and uninterrupted manner from the time they begin the work until completion of litter/debris removal at the location(s), liquidated damages will be assessed.

All litter collection and trash bag removal shall be complete within **fourteen (14) days of notification of location(s) unless a shorter time frame is determined by the Engineer**. In the event the Contractor fails to remove the litter and trash bags within the allotted time frame, liquidated damages will be assessed.

Liquidated damages for this contract are Two Hundred and Fifty Dollars (\$250.00) for each twenty-four (24) hour period that the Contractor fails to mobilize and begin litter/debris removal after seven (7) days of the initial notification, as required by this contract.

Liquidated damages for this contract are Two Hundred and Fifty Dollars (\$250.00) for each twenty-four (24) hour period that the Contractor fails to prosecute the work in a continuous and uninterrupted manner once litter/debris removal has begun.

Liquidated damages for this contract are Two Hundred and Fifty Dollars (\$250.00) for each twenty-four (24) hour period that the Contractor fails to complete the litter collection and trash bag removal within the allotted time frame from the time of notification, as required by this contract.

The Contractor shall remove all bags and piles of refuse by the end of the work day unless approved by the Engineer or his/her representative. The liquidated damages for not complying with the removal of litter/debris will be **Two Hundred Fifty Dollars (\$250.00)** per calendar day.

Any damages assessed under ICT #1 will be withheld from monies due the Contractor on the next partial payment for work accomplished and accepted.

INTERMEDIATE CONTRACT TIME NUMBER 2 AND LIQUIDATED DAMAGES

The Contractor shall not work within the roadway or associated right of way on **ANY STATE MAINTAINED ROUTE**, detain and /or alter the traffic flow on or during holiday weekends, special events, or any other time when traffic is unusually heavy, including the following schedules:

HOLIDAY AND HOLIDAY WEEKEND WORK RESTRICTIONS:

1. For **unexpected occurrence** that creates unusually high traffic volumes, as directed by the Engineer.
2. For **New Year's Day**, between the hours of **4:00 p.m.** December 31st and **8:30 a.m.** January 2nd. If New Year's Day is on a Friday, Saturday, Sunday or Monday, then until **8:30 a.m.** the following Tuesday.
3. For **Martin Luther King, Jr. Day**, between the hours of **4:00 p.m.** Friday and **8:30 a.m.** Tuesday.
4. For **Easter**, between the hours of **4:00 p.m.** Thursday and **8:30 a.m.** Monday.
5. For **Memorial Day**, between the hours of **4:00 p.m.** Friday and **8:30 a.m.** Tuesday.

6. For **Independence Day**, between the hours of **4:00 p.m.** the day before Independence Day and **8:30 a.m.** the day after Independence Day.
If **Independence Day** is on a Friday, Saturday, Sunday or Monday, then between the hours of **4:00 p.m.** the Thursday before Independence Day and **8:30 a.m.** the Tuesday after Independence Day.
7. For **Labor Day**, between the hours of **4:00 p.m.** Friday and **8:30 a.m.** Tuesday.
8. For **Veteran's Day**, between the hours of **4:00 p.m.** Friday and **8:30 a.m.** Tuesday.
9. For **Thanksgiving Day**, between the hours of **4:00 p.m.** Tuesday and **8:30 a.m.** Monday.
10. For **Christmas**, between the hours of **4:00 p.m.** the Friday before the week of Christmas Day and **8:30 a.m.** the following Tuesday after the week of Christmas Day.

Holidays and holiday weekends shall include New Years, Easter, Memorial Day, Independence Day, Labor Day, Thanksgiving, and Christmas. The Contractor shall schedule his work so that work is not required during these periods, unless otherwise directed by the Engineer.

Hours of work are restricted to daylight hours. No work will be allowed on Sundays unless approved in writing by the Engineer.

Liquidated damages for this contract are **Two Hundred Fifty Dollars (\$250.00)** per hour or portion thereof that the Contractor operates outside of the work hours as stated above.

PROGRESS AND PROSECUTION

The Contractor will be required to prosecute the work in a continuous and uninterrupted manner from the time he begins the work until completion and final acceptance of the project. The Contractor will not be permitted to suspend his operations except for reasons beyond his control or except where the Engineer has authorized a suspension of the Contractor's operations in writing.

It is further the intent that the Contractor shall pursue the work diligently with workmen in sufficient numbers, abilities, and supervision, and with the equipment, materials, and methods of construction as may be required to complete the work described in the contract, or as may be amended, by the completion date and in accordance with Section 108 of the Standard Specifications.

The Contractor's vehicles and equipment shall not be parked within the State Highway System right of way overnight or at other times when work has been suspended unless approved by the Engineer, and in no case within 30 feet of the edge of pavement. The Engineer may designate specific locations for parking equipment.

The Contractor shall adhere to all applicable regulations and follow accepted safety procedures when working in the vicinity of utilities in order to insure the safety of construction personnel and the public.

In the event that the Contractor's operations are suspended in violation of the above provisions, the sum of **Five Hundred (\$500.00)** will be charged to the contractor for each and every calendar day that such suspension takes place. The said amount is hereby agreed upon as liquidated damages. Liquidated damages chargeable due to suspension of the work will be additional to any liquidated damages that may become chargeable due to failure to complete the work by the completion date

TRAFFIC CONTROL AND WORK ZONE SAFETY

The Contractor shall maintain traffic during construction and provide, install, and maintain all traffic control devices in accordance with these project guidelines, the Project Traffic Control Plans, the Project Special Provisions, North Carolina Department of Transportation Standard Specifications for Roads and Structures, and the current edition of the Manual of Uniform Traffic Control Devices (MUTCD).

The Contractor shall utilize complete and proper traffic controls and traffic control devices during all operations. All traffic control and traffic control devices required for any operation shall be functional and in place prior to the commencement of that operation. Signs for temporary operations shall be removed during periods of inactivity. The Contractor is required to leave the project in a manner that will be safe to the traveling public and which will not impede motorists.

Traffic movements through lane closures on roads with two way traffic shall be controlled by flaggers stationed at each end of the work zone. In situations where sight distance is limited, the Contractor shall provide additional means of controlling traffic, including, but not limited to, two-way radios, pilot vehicles, or additional flaggers. Flaggers shall be competent personnel, adequately trained in flagging procedures, and furnished with proper safety devices and equipment, including, but not limited to, safety vests and stop/slow paddles.

All personnel when working in traffic areas or areas in close proximity to traffic shall wear an approved safety vest, or shirt or jacket which meets the color requirements of the Manual of Uniform Traffic Control Devices (MUTCD).

The Contractor shall comply with all applicable Federal, State, and local laws, ordinances, and regulations governing safety, health, and sanitation, and shall provide all safeguards, safety devices, and protective equipment, and shall take any other needed actions, on his own responsibility that are reasonably necessary to protect the life and health of employees on the job and the safety of the public, and to protect property in connection with the performance of the work covered by the contract.

Failure to comply with any of the requirements for safety and traffic control of this contract shall result in suspension of work as provided in Subarticle 108-7(2) of the Standard Specifications.

The Contractor's vehicles and equipment shall not be parked within the State Highway System right of way overnight or at other times when work has been suspended unless approved by the Engineer, and in no case within 30 feet of the edge of pavement. The Engineer may designate specific locations for parking equipment.

Traffic Control will be incidental to the work, and will be included in the unit bid price for the other items included in the contract.

The liquidated damages for failing to place signs before commencement of operations is **Two Hundred Fifty Dollars (\$250.00)** per incident. All signs shall be clean, legible, and in good condition as determined by the Engineer.

In addition, the Contractor shall incur immediate Liquidated Damages in the amount of **Two Hundred Fifty Dollars (\$250.00)** each occurrence for failure to provide operational lighting and signing on all equipment as specified.

SAFETY VESTS

All Contractor's personnel, all subcontractors and their personnel, and any material suppliers and their personnel, must wear a reflective safety vest or outer garment meeting ANSI/ISEA 107-2004 Class 2 standards at all times while on the project.

Failure to comply with this provision may result in a fine of **One Hundred Dollars (\$100.00)** for each occurrence.

SUPERVISION BY CONTRACTOR

At all times during the life of the project the Contractor shall provide one permanent employee who shall have the authority and capability for overall responsibility of the project and who shall be personally available at the work site within 24 hours' notice. Such employee shall be fully authorized to conduct all business with the subcontractors, to negotiate and execute all supplemental agreements, and to execute the orders or directions of the Engineer.

At all times that work is actually being performed, the Contractor shall have present on the project one competent individual who is authorized to act in a supervisory capacity over all work on the project, including work subcontracted. The individual who has been so authorized shall be experienced in the type of work being performed and shall be fully capable of managing, directing, and coordinating the work; of reading and thoroughly understanding the contract; and receiving and carrying out directions from the Engineer or his authorized representatives. He shall be an employee of the Contractor unless otherwise approved by the Engineer.

The Contractor may, at his option, designate one employee to meet the requirements of both positions. However, whenever the designated employee is absent from the work site, an authorized individual qualified to act in a supervisory capacity on the project shall be present.

INSURANCE

The Contractor shall maintain all legally required insurance coverage, including without limitation, worker's compensation and vehicle liability, in the amounts required by law. Refer to Section 107-15 in the "*Standard Specifications for Roads and Structures*" for additional information.

RESPONSIBILITY FOR DAMAGE CLAIMS

In accordance with 107-14 of the Standard Specifications. The Contractor shall indemnify and save harmless the Board of Transportation and its members and the Department of Transportation and its officers, agents, and employees from all suits, actions, or claims of any character brought for any injury or damages received or sustained by any person, persons, or property by reason of any act of the Contractor, Subcontractor, its agents or employees, in the performance of the contract.

PAYMENT AND RETAINAGE

The Contractor may submit requests for partial payments on a monthly basis, or other interval as approved by the Engineer. Compensation for all pay items shall be in accordance with the Standard Specifications. The amount of partial payments will be based on the work accomplished and accepted by the last day of the approved pay period.

Requests for payment shall be made by Contractor's Invoice. All invoice items and unit costs shall correspond to contract pay items. In the event of error or discrepancy in items or unit costs, the Department may return the invoice to the contractor for correction. The invoice shall be completely and legibly filled out with all appropriate information and shall be signed by an authorized representative of the Contractor.

All invoices shall be original and submitted to the Division Roadside Environmental Engineer for approval.

Statements of all Subcontractor payments shall be included with invoices. These statements are to be submitted on the Subcontractor Payment Information Form (DBE-IS), they shall be original and in ink.

Payment will not be made until invoices and DBE-IS forms are received. Invoices should be received by the Department within 30 days of the completion of the work.

All requests for payment shall be submitted to:

**Mr. Corey Sudderth
Division Roadside Environmental Engineer
N.C. Department of Transportation
2612 N. Duke Street
Durham, NC 27704**

Due to the nature of the contract, no retainage will be withheld. However, the Department reserves the right to withhold payment for a specific location until after successful completion of the work as verified by the final inspection of that location.

All work or items, other than those listed on the Bid Form contained in the Contract Proposal, necessary to complete this work will be considered incidental in nature and no further compensation will be made.

Payment to the Contractor will be made only for the actual quantities of the various items that are completed and accepted in accordance with the terms of the contract. The advertised bid quantities are considered to be approximate only and are given as the basis for comparison of bids. The Department of Transportation may increase or decrease the quantity of any item or portion of the work as may be deemed necessary or expedient. Unless otherwise specified, all contract pay items will be produced, placed and paid in accordance with the Standard Specifications.

PROJECT SPECIAL PROVISIONS ID/IQ**MULTI-YEAR MAINTENANCE CONTRACTS (ID/IQ):**

(4-20-21) (Rev. 4-19-22)

SP1 G75

This contract is a multi-year maintenance contract let pursuant to the provisions of N.C. General Statute §136-28.1(b). No minimum quantity of services is guaranteed to be awarded bidders under this contract. In accordance with N.C. General Statute §136-28.1(b), an award in a maintenance contract may be for an amount less but shall not exceed \$5,000,000 per year. No payments in excess of this amount will be disbursed, in accordance with the Statute.

WORK ORDER ASSIGNMENT (MULTIPLE AWARDS) FOR ID/IQ:

(2-15-22)(Rev. 4-19-22)

SPD 01-800B

Work orders will be assigned based on the lowest work order cost for the line items and estimated quantities necessary to complete the work order. Unit prices from each awarded contractor's bid will be used to determine the lowest cost for each work order. The assigned Contractor shall respond to the work order assignment with the anticipated start date, within three working days of notification unless noted otherwise. Failure on the part of the Contractor to reply within the specified time frame may be received as a rejection of the work order. If the Contractor with the lowest work order cost cannot complete the work within the time specified in the assignment, the Engineer may contact the Contractor with the next lowest work order cost. If that Contractor can complete the work within the time specified in the assignment, then the work order will be assigned to that contractor. If not, assignment of work order will continue in order of work order cost until all awarded Contractors have had a chance to accept the terms of the assignment.

For federal ID/IQ contracts, all work orders will be assigned via the Work Order Assignment form (Form IDIQ-1MA), and the Contractor is required to formally respond in writing for federal work orders within three working days, unless noted otherwise. The Work Order Assignment form will also be used for any state ID/IQ contract in which the estimated work order cost meets the threshold for Performance and Payment Bonds in accordance with the Bonding Requirements for ID/IQ provision found elsewhere in this contract. For state ID/IQ contracts in which the work order assignment doesn't meet the threshold for bonds, the Department has the option to use the Work Order Assignment Form or other methods for work order assignments as agreed upon by the Engineer and Contractor.

The Contractor shall be required to prosecute the work in a continuous and uninterrupted manner from the time they begin the work until completion and final acceptance of the work order. Multiple failures of the Contractor to mobilize and begin work on the work order within the agreed upon time frame or failure to complete the work within the given time frame may result in the Contractor being excluded from future work on this contract in accordance with the *Standard Specifications*.

MOBILIZATION AND LIQUIDATED DAMAGES FOR ID/IQ:

(2-15-22)

SPD 01-820

The Contractor shall mobilize to each location he is required to perform work. There will be no direct pay for Mobilization as it will be incidental to the other bid items. The only exception is if there is an Emergency Mobilization provision within the contract.

The Contractor will be provided a Work Order Assignment for each project with location(s), estimated quantities, and liquidated damages unless waived by the Engineer. Notification will be verbal followed by a faxed or emailed signed Work Order Assignment. There will be no minimum quantities for any line item associated with a particular mobilization. The Contractor shall complete the work identified on each Work Order Assignment.

The Contractor shall mobilize and complete the work within the time specified on the Work Order Assignment. Failure to complete the work by the completion date may result in the application of liquidated damages.

Liquidated damage amounts will be based on the work order estimate and the liquidated damage table below.

Work Order Value	Liquidated Damages (per calendar day)
\$0 - \$100K	\$100.00
\$100K - \$200K	\$250.00
\$200K - \$300K	\$500.00
\$300K - \$500K	\$600.00
\$500K - \$1M	\$700.00
\$1M - \$2M	\$850.00

RENEWAL OF CONTRACT (CPI PRICE ADJUSTMENT) FOR ID/IQ:

(2-15-22)(Rev. 9-19-23)

SPD 01-840

The Contractor shall submit a bid for one year. At the option of the Department, this contract may be extended for **two** additional periods of one year each (maximum (3) three years total). Each year shall have a limit of five million **dollars (\$5,000,000)**.

The compensation payable to the contractor shall be fixed for the first twelve months of this contract. However, upon an application of renewal of the contract, or thirty days prior to the end of each contract period, the renewal contract may be adjusted to reflect the adjustment in the Consumer Price Index over the latest twelve month period as published by the US Bureau of Labor and Statistics at <http://www.bls.gov/cpi> to be applied to new work order assignments. The Consumer Price Index for All Urban Consumers (CPI-U), US City Average, All Items, 1982-84=100, not seasonally adjusted will be used. If the amount of the requested adjustment is more than ten percent, the Department of Transportation reserves the right to cancel this contract.

CPI adjustment values can be determined using the calculator on the NCDOT Construction website.

This price escalation method will not be applied to items of work that are separately covered under commodity price escalation clauses. No other changes in the terms, conditions, etc. of this contract will be made when an extension to the contract is implemented. The Engineer will notify the Contractor in writing 60 days prior to the contract end date if the contract may be extended. The Contractor must notify the Engineer in writing within 30 days of his acceptance or rejection of this offer. Failure on the part of the Contractor to reply will be received as a rejection of contract extension.

DISPUTE RESOLUTION PROCESS FOR ID/IQ:

(2-15-22)(Rev. 1-16-24)

SPD 01-850

If a question should arise on the contract or assignment of a work order, the contractor should notify the Engineer noted on the assignment documentation or the Division Engineer within 48 hours after the scheduled time of bid opening or work order assignment. The following should be included in the notification if applicable:

- (A) the contract for which bids were solicited;
- (B) the particular law, regulation, or contract specification violated;
- (C) a detailed description of the alleged violation; and
- (D) any other information deemed to be relevant.

Once the initial evaluation has been completed, the contractor may be asked to attend a meeting for further discussion and clarification.

Once a determination has been made, the contractor will be notified of the decision by the Division Engineer. If the decision does not meet the satisfaction of the contractor, they have 24 hours from the Division Engineer’s notification to elevate the dispute to the Chief Engineer. The Chief Engineer will make the final decision and will not be subject to further review by NCDOT.

PROJECT SPECIAL PROVISIONS-ROADWAY

LITTER/DEBRIS REMOVAL AND RECYCLING

An abundance of non-organic trash in a multitude of forms is deposited daily along the roadsides of the designated highways. These conditions detract from the visual quality and/or safety of the roadside landscape.

This contract is for litter/debris removal and recycling upon request on interstate, primary and secondary roads and their interchanges within the State Maintained Highway System Right of Way in Division Five - Wake and Franklin Counties.

All items include all traffic control necessary to provide a safe work area. The work shall include the furnishing of all equipment, tools, materials, transportation and labor necessary for the successful completion of the work.

No separate payment will be made for providing, installing, and maintaining traffic control devices, etc., or for any other cost associated with maintaining the control of traffic. Traffic control will be considered incidental to the contract, and will be included in the Bid Items as listed on the Contract Bid Form.

The designated area for litter/debris removal and recycling is the entire corridor from controlled access fence to controlled access fence, or right of way width, including the median and interchange areas, to the travel lane, as directed by the Engineer, **except for along concrete barrier walls in medians. (Litter crew and vehicles are not allowed against median concrete barrier walls).** The designated area for on call litter/debris removal and recycling on shoulders is the white edge line to the back of the right of way on outside shoulders, which includes paved shoulders. The designated area for on call litter/debris removal and recycling in medians is from yellow edge line to yellow edge line, which includes paved shoulders, except for all concrete barrier walls. This includes the mowing areas as well as non-mowing areas.

Isolated Dump Sites are defined as areas measuring less than one-tenth of a shoulder mile, with excessive litter/debris accumulation, as determined by the Engineer. These sites may or may not be within the notified pickup area(s).

Isolated Bulk Items are defined as items to be picked up separately outside of the notified pickup area(s), including Isolated Dump Sites. Isolated Bulk Items may include, but not limited to, appliances, tires, tire treads, furniture, cardboard, pallets, brick, concrete block, ladders, building materials, etc. as determined by the Engineer.

The Contractor should be prepared for removing litter/debris in roadside conditions including but not limited to wet areas, standing water, high grass, and slopes. Contractor will not be responsible for removing litter/debris in wooded areas or back slopes unless litter is visible from the roadway and/or ramps.

The operation of litter/debris pickup shall be on foot only. Vehicles as specified herein may be used for bag pickup.

The Contractor must complete one (1) litter/debris pickup area prior to moving to the next (not to exceed over 5 miles). The liquidated damages are **One Hundred Dollars (\$100.00)** per incident for moving to the next area prior to completion of the existing area.

The Contractor shall provide adequate personnel and materials (litterbags) to remove litter/debris on all areas of the right-of-way or controlled access.

The operation shall include the pickup, removal and recycling of litter/debris and the disposal of same into state approved landfills and single-stream recycling facilities. Litter/debris items may consist of varied sizes of bottles, cans, paper, tires, tire pieces, lumber, vehicle parts, building supplies, metals, household furnishings, cardboard, plastics, ladders, brush and other items not considered normal to the right of way.

The Contractor shall be responsible for locating and utilizing approved local landfills and recycling facilities so as not to impede the progress of the cleanup operation.

All collected litter/debris shall be containerized immediately and kept off of the traveled portions of the roadway, shoulders, and right-of-ways (including paved shoulders) during that day's collection process. All collected litter that is small enough to be placed in a bag shall be bagged immediately. All collected litter that is too large for a bag shall be placed into a vehicle. Uncollected storage or stockpiling of litter/debris and recyclables (piles of litterbags, tires, tire debris, etc.) will not be permitted. **At no time shall bags or collected litter/debris be allowed to remain on the right of way beyond the end of the work day.**

All cost involved with the disposal of the litter/debris shall be included in the contract unit price for "Litter/Debris Removal and Recycling". Vehicles for litter/debris removal activities shall at all times be parked off the pavement as close to the right-of-way fence as possible.

The Contractor's personnel shall pickup and dispose of any litter/debris, not required to be recycled, in a landfill approved by North Carolina Division of Waste Management. Litter/debris may consist of any item not considered normal to the right-of-way. The Contractor will not be allowed to use NCDOT accounts at the landfills nor be allowed to dispose of the litter/debris in NCDOT trash containers on any NCDOT property.

The Contractor shall submit dumping ticket of the number of pounds of litter/debris not recycled to the Roadside Environmental Office with the Contractor's invoice. Clean up shall not be considered accepted by the Department until the original **DUMPING TICKET** issued to the Contractor for disposing the materials picked up during the assigned work is presented to the Department's inspector.

This contract shall be immediately terminated if the contractor is found guilty of illegal dumping. Work will be suspended if contractor is charged with illegal dumping.

The Contractor's attention is directed to North Carolina General Statute 130A-309.10 (f) through (m). Per this statute, the Contractor performing litter clean up and removal shall be required to recycle, including, but not limited to, aluminum cans, glass bottles, plastic bottles, and rubber tires collected within the right of way. In an effort to align with efforts by the Department to recycle with litter removal, the Contractor shall participate in single-stream recycling. The Contractor shall be responsible for locating and utilizing single-stream recycling facilities for disposal of recyclable litter/debris removed from the right of way as part of the work of this contract. The Contractor may recycle at any public or commercial recycling facility so long as the facility has the ability to provide weight tickets.

Assistance in locating recycling facilities may be obtained on the following websites:

<http://portal.ncdenr.org/web/deao/mrf>,
<http://www.p2pays.org/dmrm/start.aspx>,
<http://p2pays.org/localgov/ncwaste.html>.

The Contractor shall utilize blue bags, similar to those used by the Department, for the collection of recyclable materials. The Contractor will not be allowed to use NCDOT accounts at the recycling facilities nor be allowed to dispose of the litter/debris in NCDOT recycling containers on any NCDOT property.

The Contractor shall submit weight tickets of the number of pounds of each of the recycled materials listed to the Roadside Environmental Office with the Contractor's invoice. **The North Carolina Department of Transportation will require evidence of reported recycling using weight tickets from the recycling facilities.**

If the Contractor is not fulfilling the intent of the Department to participate in a recycling program it could result in termination of this contract.

The Engineer reserves the right to schedule litter/debris removal and recycling operations so as not to conflict with mowing and/or vegetation management operations. Any bags, litter, or debris that are not removed before mowing and are shredded by the mowers must still be removed.

REPORTING

The Contractor shall report online the amount of bags of litter/debris and recycling on the NCDOT Litter Management Website:

<https://apps.ncdot.gov/LM>

The Contractor is required to report all pickups on the date of the pickup. Payment for litter pickup invoiced will not be paid unless reported.

HAZARDOUS, CONTAMINATED, AND/OR TOXIC MATERIAL

The Contractor's personnel shall not be responsible for removing hazardous materials from the right-of-ways, but shall notify an NCDOT representative as soon as possible.

When the Contractor's operations encounter or expose any abnormal condition which may indicate the presence of a hazardous, contaminated, and/or toxic material, such operations shall be discontinued in the vicinity of the abnormal condition and the Engineer shall be notified immediately.

The Contractor will not be responsible for the clean-up and removal of dead animals. If this situation is encountered, the Contractor shall contact the Engineer as directed.

NOTIFICATION OF WORK

The NCDOT will notify the Contractor of each location on the state highway system where litter collection and removal is required and the time frame in which the work is to be completed. Notification may be made by telephone or email and either method shall be considered sufficient. At the time of notification the Engineer shall inform the Contractor of the system type so that the Contractor can plan their operations and work zone traffic control. **The Contractor shall notify the NCDOT by email when litter collection and trash bag removal is completed.** All work shall be subject to inspection by the Engineer at any time.

Note: It is the responsibility of the Contractor to check and read emails. Failure by the Contractor to read emails will not void the formal notification date.

MOBILIZATION

The Contractor will be required to mobilize within the specified time frame as directed by the Engineer. Mobilization shall be considered incidental to the other bid items in this contract. No direct payment will be made for Mobilization.

SAFETY

Contractor performing Work Zone Traffic Control shall have a minimum of one (1) NCDOT Certified Work Zone Supervisor. At no time during the contract is the Contractor to be without a NCDOT Certified Work Zone Supervisor. The NCDOT Certified Work Zone Supervisor must be on site during any traffic control activities that take place within the travel lane or otherwise alter the flow of traffic.

All stages of the litter/debris removal operation shall be accomplished in accordance with the "Work Zone Traffic Control Guidance for Litter/Debris Removal" in the Appendix. The NCDOT Certified Work Zone Supervisor shall submit traffic control plans for the approval of the Engineer, who may adjust or require additional control measures if warranted.

All Contractors' personnel, all subcontractors and their personnel must wear steel toed work boots that meet ASTM F2412.05 and long pants. The Contractor will be held responsible for all damage or injury to property of any character resulting from any act, omission, negligence, or misconduct in the prosecution of the work. When any

direct or indirect damage or injury is done to public or private property by or on account of any act, omission, negligence, or misconduct in the execution of the work, the Contractor shall either restore at his/her own expense such property to a condition similar or equal to that existing before such damage or injury was done, or shall make good such damage or injury in a manner acceptable to the owner of the damaged property and to the Department. In case of failure on the part of the Contractor to restore such property or make good such damage or injury the Department may at the Contractor's expense repair, rebuild, or otherwise restore such property in such manner, as the Engineer may consider necessary.

The Contractor's operations are restricted to daylight hours. Work shall only be performed when weather and visibility conditions allow safe operations.

EQUIPMENT REQUIREMENTS

The Contractor shall furnish equipment of sufficient type, capacity, and quantity to safely and efficiently perform the litter/debris removal work. All vehicles used by the Contractor must be performance worthy by visual and operational inspection. The Contractor shall display and telephone number the company name on each piece of equipment. Side by side utility vehicles with beds capable of carrying litter bags with specified warning lights may be allowed for bag pickup only. Four wheeler vehicles will not be allowed.

All vehicles, including trailers, used in the removal operation should be properly equipped with lighting per Roadway Standard Drawing 1165.01 Sheet 1 of 1. Trailers shall have rear mounted strobe lights, mounted as high as possible to enhance visibility.

The Contractor shall furnish, mount, and maintain a W10-11 or W10-11A "DEBRIS PICK UP FREQUENT STOPS" sign on the rear of each vehicle or trailer such that they can be easily read by motorists approaching from the rear. Details of the sign is included in the "Work Zone Traffic Control Guidance for Litter/Debris Removal" of this proposal. The sign must not obstruct any safety lighting or the operator's view.

The Contractor shall be responsible for the equipment provided in this contract at all times and at all locations during the term of the contract. The Contractor shall have no claim against the Department of Transportation for any expense involving damage or loss to the Contractor's equipment (including vandalism, theft, fire and acts of God, etc.) arising out of, or relating to, work performed under this agreement.

The safety of the public and the convenience of traffic shall be regarded as prime importance. The Contractor shall operate the equipment in a safe manner so as not to create a hazard to the traveling public. Crossing lanes of traffic and erratic driving will be strictly prohibited.

Signs, lights, safety, and other traffic control items are not a pay item, but are considered incidental to other contract items and the Contractor is expected to provide these items.

EQUIPMENT IDLING GUIDELINES:

(1-19-21)

107

SP1 G096

Exercise reduced fuel consumption and reduced equipment emissions during the construction of all work associated with this contract. Employees engaged in the construction of this project should turn off vehicles when stopped for more than thirty (30) minutes and off-highway equipment should idle no longer than fifteen (15) consecutive minutes.

These guidelines for turning off vehicles and equipment when idling do not apply to:

1. Idling when queuing.
2. Idling to verify the vehicle is in safe operating condition.
3. Idling for testing, servicing, repairing or diagnostic purposes.
4. Idling necessary to accomplish work for which the vehicle was designed (such as operating a crane, mixing concrete, etc.).
5. Idling required to bring the machine system to operating temperature.

6. Emergency vehicles, utility company, construction, and maintenance vehicles where the engines must run to perform needed work.
7. Idling to ensure safe operation of the vehicle.
8. Idling when the propulsion engine is providing auxiliary power for other than heating or air conditioning. (such as hydraulic systems for pavers)
9. When specific traffic, safety, or emergency situations arise.
10. If the ambient temperature is less than 32 degrees Fahrenheit. Limited idling to provide for the safety of vehicle occupants (e.g. to run the heater).
11. If the ambient temperature is greater than 90 degrees Fahrenheit. Limited idling to provide for the safety of vehicle occupants of off-highway equipment (e.g. to run the air conditioning) no more than 30 minutes.
12. Diesel powered vehicles may idle for up to 30 minutes to minimize restart problems.

Any vehicle, truck, or equipment in which the primary source of fuel is natural gas or electricity is exempt from the idling limitations set forth in this special provision.

BID ITEMS

This contract will consist of the following seven (7) pay items:

1. **Litter/Debris Removal and Recycling on Interstate Highways per Shoulder Mile:** This item will account for the litter/debris removal and recycling along interstate highways. The designated area for litter/debris removal will be the entire highway corridor from control fence to control fence or the entire right of way width, including median and interchange areas as directed by the Engineer.
2. **Litter/Debris Removal and Recycling on Primary Divided Highways per Shoulder Mile:** This item will account for the litter/debris removal and recycling along urban and rural primary divided highways. The designated area for litter/debris removal will be the entire highway corridor from control fence to control fence or the entire right of way width, including median and interchange areas as directed by the Engineer.
3. **Litter/Debris Removal and Recycling on Primary Undivided Highways per Shoulder Mile:** This item will account for the litter/debris removal and recycling along urban and rural primary undivided highways. The designated area for litter/debris removal will be the entire right of way width or as directed by the Engineer.
4. **Litter/Debris Removal and Recycling on Secondary Divided Highways per Shoulder Mile:** This item will account for the litter/debris removal and recycling along urban and rural secondary divided highways. The designated area for litter/debris removal will be the entire highway corridor from control fence to control fence or the entire right of way width, including median and interchange areas as directed by the Engineer.
5. **Litter/Debris Removal and Recycling on Secondary Undivided Highways per Shoulder Mile:** This item will account for the litter/debris removal and recycling along urban and rural secondary undivided highways. The designated area for litter/debris removal will be the entire right of way width or as directed by the Engineer.
6. **Litter/Debris Removal and Recycling at Isolated Dump Sites per Each:** This item will account for the litter/debris removal and recycling at isolated dump sites along highways. The designated area for litter/debris removal will be the entire right of way length and/or width, or as directed by the Engineer.
7. **Litter/Debris Removal and Recycling of Isolated Bulk Items per Each.** This item will account for the litter/debris removal and recycling of isolated bulk item(s) along highways. The designated item(s) for litter/debris removal will be as directed by the Engineer.

QUALITY, INSPECTION AND BASIS OF ACCEPTANCE

It is intended that the work will be completed in a neat, continuous, and uninterrupted manner as determined by the Engineer. Completed work shall be clean and free of all accumulated litter/debris immediately after litter/debris removal and recycling. All work shall be subject to inspection by the Engineer at any time. The Engineer or a designated representative will make periodic next day inspections of the completed work. **It will be the responsibility of the Contractor to keep the Engineer informed of his/her proposed work plan by submitting weekly reports of work accomplished and of planned work for the upcoming week. The Contractor shall notify the NCDOT by email when litter collection and trash bag removal is completed.**

The Department of Transportation will verify completion of the Contractor's work on a monthly basis before payment of invoice.

METHOD OF MEASUREMENT

The quantity of Litter/Debris Removal and Recycling will be measured to the nearest (0.1) tenth of a mile for each Shoulder Mile of Litter/Debris Removal and Recycling work accomplished and accepted.

Highway mileage will be determined from NCDOT county maintenance maps. In the case of dispute or obvious error, the mileage shall be measured by a representative of the North Carolina Department of Transportation and the Contractor. Normally one (1) map mile of undivided roadway shall equal two (2) shoulder miles and one (1) map mile of divided roadway shall equal four (4) shoulder miles.

BASIS OF PAYMENT

The quantity of Litter/Debris Removal and Recycling on Primary Divided Highways, measured as provided above, will be paid for at the **Shoulder Mile** price for "Litter/Debris Removal and Recycling on Interstate Highways".

The quantity of Litter/Debris Removal and Recycling on Primary Divided Highways, measured as provided above, will be paid for at the **Shoulder Mile** price for "Litter/Debris Removal and Recycling on Primary Divided Highways".

The quantity of Litter/Debris Removal and Recycling on Primary Undivided Highways, measured as provided above, will be paid for at the **Shoulder Mile** price for "Litter/Debris Removal and Recycling on Primary Undivided Highways".

The quantity of Litter/Debris Removal and Recycling on Secondary Divided Highways, measured as provided above, will be paid for at the **Shoulder Mile** price for "Litter/Debris Removal and Recycling on Secondary Divided Highways".

The quantity of Litter/Debris Removal and Recycling on Secondary Undivided Highways, measured as provided above, will be paid for at the **Shoulder Mile** price for "Litter/Debris Removal and Recycling on Secondary Undivided Highways".

The quantity of Litter/Debris Removal and Recycling at Isolated Dump Sites will be paid for at the **Each** price for "Isolated Dump Sites".

The quantity of Litter/Debris Removal and Recycling of Isolated Bulk Items will be paid for at the **Each** price for "Isolated Bulk Items".

Bid prices and payments will be full compensation for all work, including but not limited to supervision, labor, transportation, fuels, lubricants, repair parts, equipment, machinery, tools, and dumping fees, necessary for the prosecution and completion of the work. Payments will be made to the Contractor for work accomplished and accepted.

Payment for these items will be made for as follows:

Litter/Debris Removal and Recycling on Interstate Highways	SHM
Litter/Debris Removal and Recycling on Primary Divided Highways	SHM
Litter/Debris Removal and Recycling on Primary Undivided Highways	SHM
Litter/Debris Removal and Recycling on Secondary Divided Highways	SHM
Litter/Debris Removal and Recycling on Secondary Undivided Highways	SHM
Isolated Dump Sites	EA
Isolated Bulk Items	EA

MINORITY BUSINESS ENTERPRISE AND WOMEN BUSINESS ENTERPRISE (DIVISIONS):

(10-16-07)(Rev. 5-9-24)

102-15(J)

SPI G67

Description

The purpose of this Special Provision is to carry out the North Carolina Department of Transportation’s policy of ensuring nondiscrimination in the award and administration of contracts financed in whole or in part with State funds.

Definitions

Additional MBE/WBE Subcontractors - Any MBE/WBE submitted at the time of bid that will not be used to meet the Combined MBE/WBE goal. No submittal of a Letter of Intent is required.

Combined MBE/WBE Goal: A portion of the total contract, expressed as a percentage that is to be performed by committed MBE/WBE subcontractors.

Committed MBE/WBE Subcontractor - Any MBE/WBE submitted at the time of bid that is being used to meet the Combined MBE / WBE goal by submission of a Letter of Intent. Or any MBE or WBE used as a replacement for a previously committed MBE or WBE firm.

Contract Goal Requirement - The approved participation at time of award, but not greater than the advertised Combined MBE/WBE contract goal.

Goal Confirmation Letter - Written documentation from the Department to the bidder confirming the Contractor's approved, committed participation along with a listing of the committed MBE and WBE firms.

Manufacturer - A firm that owns (or leases) and operates or maintains a factory or establishment that produces on the premises, the materials or supplies obtained by the Contractor. A firm that makes minor modifications to the materials, supplies, articles, or equipment is not a manufacturer.

MBE Participation (Anticipated) - A portion of the total contract, expressed as a percentage that is anticipated to be performed by committed MBE subcontractor(s).

Minority Business Enterprise (MBE) - A firm certified as a Disadvantaged Minority-Owned Business Enterprise through the North Carolina Unified Certification Program.

Regular Dealer - A firm that owns (or leases), and operates a store, warehouse, or other establishment in which the materials or supplies required for the performance of the contract are bought, kept in sufficient quantities, and regularly sold to the public in the usual course of business. A regular dealer engages in, as its principal business and in its own name, the purchase and sale or lease of the products in question. A regular dealer in such bulk items as steel, concrete or concrete products, gravel, stone, asphalt and petroleum products need not keep such products in stock, if it owns and operates distribution equipment for the products. Any supplement of regular dealers’ own distribution equipment shall be by a long-term operating lease and not on an ad hoc or contract-by-contract basis.

Distributor – A firm that engages in the regular sale or lease of the items specified by the contract. A distributor assumes responsibility for the items it purchases once they leave the point of origin (e.g., a manufacturer’s facility), making it liable for any loss or damage not covered by the carrier’s insurance.

Replacement / Substitution – A full or partial reduction in the amount of work subcontracted to a committed (or an approved substitute) MBE/WBE firm.

North Carolina Unified Certification Program (NCUCP) - A program that provides comprehensive services and information to applicants for MBE/WBE certification. The MBE/WBE program follows the same regulations as the federal Disadvantaged Business Enterprise (DBE) program in accordance with 49 CFR Part 26.

United States Department of Transportation (USDOT) - Federal agency responsible for issuing regulations (49 CFR Part 26) and official guidance for the DBE program.

WBE Participation (Anticipated) - A portion of the total contract, expressed as a percentage that is anticipated to be performed by committed WBE subcontractor(s).

Women Business Enterprise (WBE) - A firm certified as a Disadvantaged Women-Owned Business Enterprise through the North Carolina Unified Certification Program.

Forms and Websites Referenced in this Provision

Payment Tracking System - On-line system in which the Contractor enters the payments made to MBE and WBE subcontractors who have performed work on the project. <https://apps.dot.state.nc.us/Vendor/PaymentTracking/>

DBE-IS Subcontractor Payment Information - Form for reporting the payments made to all MBE/WBE firms working on the project. This form is for paper bid projects only. <https://connect.ncdot.gov/business/Turnpike/Documents/Form%20DBE-IS%20Subcontractor%20Payment%20Information.pdf>

RF-1 MBE/WBE Replacement Request Form - Form for replacing a committed MBE or WBE. <https://connect.ncdot.gov/projects/construction/Construction%20Forms/DBE%20MBE%20WBE%20Replacement%20Form%20and%20Instructions.pdf>

SAF Subcontract Approval Form - Form required for approval to sublet the contract. <https://connect.ncdot.gov/projects/construction/Construction%20Forms/SAF%20Form%20-%20Subcontract%20Approval%20Form%20Revised%202004-19.xlsm>

JC-1 Joint Check Notification Form - Form and procedures for joint check notification. The form acts as a written joint check agreement among the parties providing full and prompt disclosure of the expected use of joint checks. <http://connect.ncdot.gov/projects/construction/Construction%20Forms/Joint%20Check%20Notification%20Form.pdf>

Letter of Intent - Form signed by the Contractor and the MBE/WBE subcontractor, manufacturer or regular dealer that affirms that a portion of said contract is going to be performed by the signed MBE/WBE for the estimated amount (based on quantities and unit prices) listed at the time of bid. <http://connect.ncdot.gov/letting/LetCentral/Letter%20of%20Intent%20to%20Perform%20as%20a%20Subcontractor.pdf>

Listing of MBE and WBE Subcontractors Form - Form for entering MBE/WBE subcontractors on a project that will meet the Combined MBE/WBE goal. This form is for paper bids only. [http://connect.ncdot.gov/municipalities/Bid%20Proposals%20for%20LGA%20Content/09%20MBE-WBE%20Subcontractors%20\(State\).docx](http://connect.ncdot.gov/municipalities/Bid%20Proposals%20for%20LGA%20Content/09%20MBE-WBE%20Subcontractors%20(State).docx)

Subcontractor Quote Comparison Sheet - Spreadsheet for showing all subcontractor quotes in the work areas where MBEs and WBEs quoted on the project. This sheet is submitted with good faith effort packages.

<http://connect.ncdot.gov/business/SmallBusiness/Documents/DBE%20Subcontractor%20Quote%20Comparison%20Example.xls>

DBE Regular Dealer/Distributor Affirmation Form – Form is used to make a preliminary counting determination for each DBE listed as a regular dealer or distributor to assess its eligibility for 60 or 40 percent credit, respectively of the cost of materials or supplies based on its demonstrated capacity and intent to perform as a regular dealer or distributor, as defined in section 49 CFR 26.55 under the contract at issue. A Contractor will submit the completed form with the Letter of Intent.

<https://connect.ncdot.gov/projects/construction/Construction%20Forms/DBE%20Regular%20Dealer-Distributor%20Affirmation%20Form%20-%20USDOT%202024.pdf>

Combined MBE/WBE Goal

The Combined MBE/WBE Goal for this project is **zero 0 %**

The Combined Goal was established utilizing the following anticipated participation for Minority Business Enterprises and Women Business Enterprises:

(A) Minority Business Enterprises **zero 0 %**

- (1) *If the anticipated MBE participation is more than zero*, the Contractor shall exercise all necessary and reasonable steps to ensure that MBEs participate in at least the percent of the contract as set forth above.
- (2) *If the anticipated MBE participation is zero*, the Contractor shall make an effort to recruit and use MBEs during the performance of the contract. Any MBE participation obtained shall be reported to the Department.

(B) Women Business Enterprises **zero 0 %**

- (1) *If the anticipated WBE participation is more than zero*, the Contractor shall exercise all necessary and reasonable steps to ensure that WBEs participate in at least the percent of the contract as set forth above.
- (2) *If the anticipated WBE participation is zero*, the Contractor shall make an effort to recruit and use WBEs during the performance of the contract. Any WBE participation obtained shall be reported to the Department.

The Bidder is required to submit only participation to meet the Combined MBE/WBE Goal. The Combined Goal may be met by submitting all MBE participation, all WBE participation, or a combination of MBE and WBE participation.

Directory of Transportation Firms (Directory)

Real-time information is available about firms doing business with the Department and firms that are certified through NCUCP in the Directory of Transportation Firms. Only firms identified in the Directory as MBE and WBE certified shall be used to meet the Combined MBE / WBE goal. The Directory can be found at the following link.

<https://www.ebs.nc.gov/VendorDirectory/default.html>

The listing of an individual firm in the directory shall not be construed as an endorsement of the firm's capability to perform certain work.

Listing of MBE/WBE Subcontractors

At the time of bid, bidders shall submit all MBE and WBE participation that they anticipate to use during the life of the contract. Only those identified to meet the Combined MBE/WBE goal will be considered committed, even though the listing shall include both committed MBE/WBE subcontractors and additional MBE/WBE subcontractors. Any

additional MBE/WBE subcontractor participation above the goal will follow the banking guidelines found elsewhere in this provision. All other additional MBE/WBE subcontractor participation submitted at the time of bid will be used toward the Department's overall race-neutral goals. Only those firms with current MBE and WBE certification at the time of bid opening will be acceptable for listing in the bidder's submittal of MBE and WBE participation. The Contractor shall indicate the following required information:

(A) Electronic Bids

Bidders shall submit a listing of MBE and WBE participation in the appropriate section of the electronic submittal file.

- (1) Submit the names and addresses of MBE and WBE firms identified to participate in the contract. If the bidder uses the updated listing of MBE and WBE firms shown in the electronic submittal file, the bidder may use the dropdown menu to access the name and address of the firms.
- (2) Submit the contract line numbers of work to be performed by each MBE and WBE firm. When no figures or firms are entered, the bidder will be considered to have no MBE or WBE participation.
- (3) The bidder shall be responsible for ensuring that the MBE and WBE are certified at the time of bid by checking the Directory of Transportation Firms. If the firm is not certified at the time of the bid-letting, that MBE's or WBE's participation will not count towards achieving the Combined MBE/WBE goal.

(B) Paper Bids

- (1) *If the Combined MBE/ WBE goal is more than zero,*
 - (a) Bidders, at the time the bid proposal is submitted, shall submit a listing of MBE/WBE participation, including the names and addresses on *Listing of MBE and WBE Subcontractors* contained elsewhere in the contract documents in order for the bid to be considered responsive. Bidders shall indicate the total dollar value of the MBE and WBE participation for the contract.
 - (b) If bidders have no MBE or WBE participation, they shall indicate this on the *Listing of MBE and WBE Subcontractors* by entering the word "None" or the number "0." This form shall be completed in its entirety. **Blank forms will not be deemed to represent zero participation.** Bids submitted that do not have MBE and WBE participation indicated on the appropriate form will not be read publicly during the opening of bids. The Department will not consider these bids for award and the proposal will be rejected.
 - (c) The bidder shall be responsible for ensuring that the MBE/WBE is certified at the time of bid by checking the Directory of Transportation Firms. If the firm is not certified at the time of the bid-letting, that MBE's or WBE's participation will not count towards achieving the Combined MBE/WBE goal.
- (2) *If the Combined MBE/WBE Goal is zero,* entries on the *Listing of MBE and WBE Subcontractors* are not required for the zero goal, however any MBE or WBE participation that is achieved during the project shall be reported in accordance with requirements contained elsewhere in the special provision.

MBE or WBE Prime Contractor

When a certified MBE or WBE firm bids on a contract that contains a Combined MBE/WBE Goal, the firm is responsible for meeting the goal or making good faith efforts to meet the goal, just like any other bidder. In most cases, a MBE or WBE bidder on a contract will meet the Combined MBE/WBE goal by virtue of the work it performs on the contract with its own forces. However, all the work that is performed by the MBE or WBE bidder and any

other similarly certified subcontractors will count toward the goal. The MBE or WBE bidder shall list itself along with any MBE or WBE subcontractors, if any, in order to receive credit toward the goals.

MBE/WBE prime contractors shall also follow Sections A or B listed under *Listing of MBE/WBE Subcontractors* just as a non-MBE/WBE bidder would.

Written Documentation – Letter of Intent

The bidder shall submit written documentation for each MBE/WBE that will be used to meet the Combined MBE/WBE goal of the contract, indicating the bidder's commitment to use the MBE/WBE in the contract. This documentation shall be submitted on the Department's form titled *Letter of Intent*.

The documentation shall be received in the office of the Engineer no later than 2:00 p.m. of the fifth calendar day following opening of bids, unless the fifth day falls on Saturday, Sunday or an official state holiday. In that situation, it is due in the office of the Engineer no later than 10:00 a.m. on the next official state business day.

If the bidder fails to submit the Letter of Intent from each committed MBE and WBE to be used toward the Combined MBE/WBE goal, or if the form is incomplete (i.e. both signatures are not present), the MBE/WBE participation will not count toward meeting the Combined MBE/WBE goal. If the lack of this participation drops the commitment below the Combined MBE/WBE goal, the Contractor shall submit evidence of good faith efforts for the goal not met, completed in its entirety, to the Engineer no later than 2:00 p.m. of the eighth calendar day following opening of bids, unless the eighth day falls on Saturday, Sunday or an official state holiday. In that situation, it is due in the office of the Engineer no later than 10:00 a.m. on the next official state business day.

Banking MBE/WBE Credit

If the committed MBE/WBE participation submitted exceeds the algebraic sum of the Combined MBE/WBE goal by \$1,000 or more, the excess will be placed on deposit by the Department for future use by the bidder. Separate accounts will be maintained for MBE and WBE participation and these may accumulate for a period not to exceed 24 months.

When the apparent lowest responsive bidder fails to submit sufficient participation by MBE and WBE firms to meet the advertised goal, as part of the good faith effort, the Department will consider allowing the bidder to withdraw funds to meet the Combined MBE/WBE goal as long as there are adequate funds available from the bidder's MBE and WBE bank accounts.

Submission of Good Faith Effort

If the bidder fails to meet or exceed the Combined MBE/WBE goal, the apparent lowest responsive bidder shall submit to the Department documentation of adequate good faith efforts made to reach that specific goal.

One complete set and **two** copies of this information shall be received in the office of the Engineer no later than 2:00 p.m. of the fifth calendar day following opening of bids, unless the fifth day falls on Saturday, Sunday or an official state holiday. In that situation, it is due in the office of the Engineer no later than 10:00 a.m. on the next official state business day.

Note: Where the information submitted includes repetitious solicitation letters, it will be acceptable to submit a representative letter along with a distribution list of the firms that were solicited. Documentation of MBE/WBE quotations shall be a part of the good faith effort submittal. This documentation may include written subcontractor quotations, telephone log notations of verbal quotations, or other types of quotation documentation.

Consideration of Good Faith Effort for Projects with a Combined MBE/WBE Goal More Than Zero

Adequate good faith efforts mean that the bidder took all necessary and reasonable steps to achieve the goal which, by their scope, intensity, and appropriateness, could reasonably be expected to obtain sufficient MBE/WBE participation. Adequate good faith efforts also mean that the bidder actively and aggressively sought MBE/WBE participation. Mere *pro forma* efforts are not considered good faith efforts.

The Department will consider the quality, quantity, and intensity of the different kinds of efforts a bidder has made. Listed below are examples of the types of actions a bidder will take in making a good faith effort to meet the goals and are not intended to be exclusive or exhaustive, nor is it intended to be a mandatory checklist.

- (A) Soliciting through all reasonable and available means (e.g. attendance at pre-bid meetings, advertising, written notices, use of verifiable electronic means through the use of the NCDOT Directory of Transportation Firms) the interest of all certified MBEs/WBEs that are also prequalified subcontractors. The bidder must solicit this interest within at least 10 days prior to bid opening to allow the MBEs/WBEs to respond to the solicitation. Solicitation shall provide the opportunity to MBEs/WBEs within the Division and surrounding Divisions where the project is located. The bidder must determine with certainty if the MBEs/WBEs are interested by taking appropriate steps to follow up initial solicitations.
- (B) Selecting portions of the work to be performed by MBEs/WBEs in order to increase the likelihood that the Combined MBE/WBE goal will be achieved.
 - (1) Where appropriate, break out contract work items into economically feasible units to facilitate MBE/WBE participation, even when the prime contractor might otherwise prefer to perform these work items with its own forces.
 - (2) Negotiate with subcontractors to assume part of the responsibility to meet the advertised goal when the work to be sublet includes potential for MBE/WBE participation (2nd and 3rd tier subcontractors).
- (C) Providing interested certified MBEs/WBEs that are also prequalified subcontractors with adequate information about the plans, specifications, and requirements of the contract in a timely manner to assist them in responding to a solicitation.
- (D)
 - (1) Negotiating in good faith with interested MBEs/WBEs. It is the bidder's responsibility to make a portion of the work available to MBE/WBE subcontractors and suppliers and to select those portions of the work or material needs consistent with the available MBE/WBE subcontractors and suppliers, so as to facilitate MBE/WBE participation. Evidence of such negotiation includes the names, addresses, and telephone numbers of MBEs/WBEs that were considered; a description of the information provided regarding the plans and specifications for the work selected for subcontracting; and evidence as to why additional agreements could not be reached for MBEs/WBEs to perform the work.
 - (2) A bidder using good business judgment would consider a number of factors in negotiating with subcontractors, including MBE/WBE subcontractors, and would take a firm's price and capabilities as well as the advertised goal into consideration. However, the fact that there may be some additional costs involved in finding and using MBEs/WBEs is not in itself sufficient reason for a bidder's failure to meet the advertised goal, as long as such costs are reasonable. Also, the ability or desire of a prime contractor to perform the work of a contract with its own organization does not relieve the bidder of the responsibility to make good faith efforts. Bidding contractors are not, however, required to accept higher quotes from MBEs/WBEs if the price difference is excessive or unreasonable.
- (E) Not rejecting MBEs/WBEs as being unqualified without sound reasons based on a thorough investigation of their capabilities. The bidder's standing within its industry, membership in specific groups, organizations, or associates and political or social affiliations (for example, union vs. non-union employee status) are not legitimate causes for the rejection or non-solicitation of bids in the bidder's efforts to meet the project goal.
- (F) Making efforts to assist interested MBEs/WBEs in obtaining bonding, lines of credit, or insurance as required by the recipient or bidder.
- (G) Making efforts to assist interested MBEs/WBEs in obtaining necessary equipment, supplies, materials, or related assistance or services.

- (H) Effectively using the services of available minority/women community organizations; minority/women contractors' groups; Federal, State, and local minority/women business assistance offices; and other organizations as allowed on a case-by-case basis to provide assistance in the recruitment and placement of MBEs/WBEs. Contact within 7 days from the bid opening the Business Opportunity and Work Force Development Unit at BOWD@ncdot.gov to give notification of the bidder's inability to get MBE or WBE quotes.
- (I) Any other evidence that the bidder submits which shows that the bidder has made reasonable good faith efforts to meet the advertised goal.

In addition, the Department may take into account the following:

- (1) Whether the bidder's documentation reflects a clear and realistic plan for achieving the Combined MBE/WBE goal.
- (2) The bidders' past performance in meeting the contract goal.
- (3) The performance of other bidders in meeting the advertised goal. For example, when the apparent successful bidder fails to meet the goal, but others meet it, you may reasonably raise the question of whether, with additional reasonable efforts the apparent successful bidder could have met the goal. If the apparent successful bidder fails to meet the advertised goal, but meets or exceeds the average MBE and WBE participation obtained by other bidders, the Department may view this, in conjunction with other factors, as evidence of the apparent successful bidder having made a good faith effort.

If the Department does not award the contract to the apparent lowest responsive bidder, the Department reserves the right to award the contract to the next lowest responsive bidder that can satisfy to the Department that the Combined MBE/WBE goal can be met or that an adequate good faith effort has been made to meet the advertised goal.

Non-Good Faith Appeal

The Engineer will notify the Contractor verbally and in writing of non-good faith. A Contractor may appeal a determination of non-good faith made by the Goal Compliance Committee. If a Contractor wishes to appeal the determination made by the Committee, they shall provide written notification to the Engineer. The appeal shall be made within 2 business days of notification of the determination of non-good faith.

Counting MBE/WBE Participation Toward Meeting the Combined MBE/WBE Goal

(A) Participation

The total dollar value of the participation by a committed MBE/WBE will be counted toward the contract goal requirements. The total dollar value of participation by a committed MBE/WBE will be based upon the value of work performed by the MBE/WBE and the actual payments to MBE/WBE firms by the Contractor.

(B) Joint Checks

Prior notification of joint check use shall be required when counting MBE/WBE participation for services or purchases that involves the use of a joint check. Notification shall be through submission of Form JC-1 (*Joint Check Notification Form*) and the use of joint checks shall be in accordance with the Department's Joint Check Procedures.

(C) Subcontracts (Non-Trucking)

A MBE/WBE may enter into subcontracts. Work that a MBE subcontracts to another MBE firm may be counted toward the anticipated MBE participation. The same holds for work that a WBE subcontracts to

another WBE firm. Work that a MBE/WBE subcontracts to a non-MBE/WBE firm does not count toward the contract goal requirement. It should be noted that every effort shall be made by MBE and WBE contractors to subcontract to the same certification (i.e., MBEs to MBEs and WBEs to WBEs), in order to fulfill the MBE or WBE participation breakdown. This, however, may not always be possible due to the limitation of firms in the area. If the MBE or WBE firm shows a good faith effort has been made to reach out to similarly certified firms and there is no interest or availability, and they can get assistance from other certified firms, the Engineer will not hold the prime responsible for meeting the individual MBE or WBE breakdown. If a MBE or WBE contractor or subcontractor subcontracts a significantly greater portion of the work of the contract than would be expected on the basis of standard industry practices, it shall be presumed that the MBE or WBE is not performing a commercially useful function.

(D) Joint Venture

When a MBE or WBE performs as a participant in a joint venture, the Contractor may count toward its contract goal requirement a portion of the total value of participation with the MBE or WBE in the joint venture, that portion of the total dollar value being a distinct clearly defined portion of work that the MBE or WBE performs with its forces.

(E) Manufacturer, Regular Dealer, Distributor

A Contractor may count toward its MBE/WBE requirement 40 percent of its expenditures for materials or supplies (including transportation costs) from a MBE/WBE distributor, 60 percent of its expenditures for materials or supplies (including transportation costs) from a MBE/WBE regular dealer and 100 percent of such expenditures obtained from a MBE/WBE manufacturer.

A Contractor may count toward its MBE/WBE requirement the following expenditures to MBE/WBE firms that are not manufacturers, regular dealers or distributors:

- (1) The fees or commissions charged by a MBE/WBE firm for providing a *bona fide* service, such as professional, technical, consultant, or managerial services, or for providing bonds or insurance specifically required for the performance of a DOT-assisted contract, provided the fees or commissions are determined to be reasonable and not excessive as compared with fees and commissions customarily allowed for similar services.
- (2) With respect to materials or supplies purchased from a MBE/WBE, which is neither a manufacturer, regular dealer, nor a distributor count the entire amount of fees or commissions charged that the Department deems to be reasonable, including transportation charges for the delivery of materials or supplies. Do not count any portion of the cost of the materials and supplies themselves.

A Contractor will submit a completed *DBE Regular Dealer/Distributor Affirmation Form* with the Letter of Intent to the Engineer. The Engineer will forward to the State Contractor Utilization Engineer or DBE@ncdot.gov. The State Contractor Utilization Engineer will make a preliminary assessment as to whether a MBE/WBE supplier has the demonstrated capacity to perform a commercially useful function (CUF) on a contract-by-contract basis *prior* to its participation.

Commercially Useful Function

(A) MBE/WBE Utilization

The Contractor may count toward its contract goal requirement only expenditures to MBEs and WBEs that perform a commercially useful function in the work of a contract. A MBE/WBE performs a commercially useful function when it is responsible for execution of the work of the contract and is carrying out its responsibilities by performing, managing, and supervising the work involved. To perform a commercially useful function, the MBE/WBE shall also be responsible with respect to materials and supplies used on the contract, for negotiating price, determining quality and quantity, ordering the material and installing (where

applicable) and paying for the material itself. To determine whether a MBE/WBE is performing a commercially useful function, the Department will evaluate the amount of work subcontracted, industry practices, whether the amount the firm is to be paid under the contract is commensurate with the work it is performing and the MBE/WBE credit claimed for its performance of the work, and any other relevant factors. If it is determined that a MBE or WBE is not performing a Commercially Useful Function, the contractor may present evidence to rebut this presumption to the Department.

(B) MBE/WBE Utilization in Trucking

The following factors will be used to determine if a MBE or WBE trucking firm is performing a commercially useful function:

- (1) The MBE/WBE shall be responsible for the management and supervision of the entire trucking operation for which it is responsible on a particular contract, and there shall not be a contrived arrangement for the purpose of meeting the Combined MBE/WBE goal.
- (2) The MBE/WBE shall itself own and operate at least one fully licensed, insured, and operational truck used on the contract.
- (3) The MBE/WBE receives credit for the total value of the transportation services it provides on the contract using trucks it owns, insures, and operates using drivers it employs.
- (4) The MBE may subcontract the work to another MBE firm, including an owner-operator who is certified as a MBE. The same holds true that a WBE may subcontract the work to another WBE firm, including an owner-operator who is certified as a WBE. When this occurs, the MBE or WBE who subcontracts work receives credit for the total value of the transportation services the subcontracted MBE or WBE provides on the contract. It should be noted that every effort shall be made by MBE and WBE contractors to subcontract to the same certification (i.e., MBEs to MBEs and WBEs to WBEs), in order to fulfill the participation breakdown. This, however, may not always be possible due to the limitation of firms in the area. If the MBE or WBE firm shows a good faith effort has been made to reach out to similarly certified transportation service providers and there is no interest or availability, and they can get assistance from other certified providers, the Engineer will not hold the prime responsible for meeting the individual MBE or WBE participation breakdown.
- (5) The MBE/WBE may also subcontract the work to a non-MBE/WBE firm, including from an owner-operator. The MBE/WBE who subcontracts the work to a non-MBE/WBE is entitled to credit for the total value of transportation services provided by the non-MBE/WBE subcontractor not to exceed the value of transportation services provided by MBE/WBE-owned trucks on the contract. Additional participation by non-MBE/WBE subcontractors receives credit only for the fee or commission it receives as a result of the subcontract arrangement. The value of services performed under subcontract agreements between the MBE/WBE and the Contractor will not count towards the MBE/WBE contract requirement.
- (6) A MBE/WBE may lease truck(s) from an established equipment leasing business open to the general public. The lease must indicate that the MBE/WBE has exclusive use of and control over the truck. This requirement does not preclude the leased truck from working for others during the term of the lease with the consent of the MBE/WBE, so long as the lease gives the MBE/WBE absolute priority for use of the leased truck. This type of lease may count toward the MBE/WBE's credit as long as the driver is under the MBE/WBE's payroll.
- (7) Subcontracted/leased trucks shall display clearly on the dashboard the name of the MBE/WBE that they are subcontracted/leased to and their own company name if it is not identified on the truck itself. Magnetic door signs are not permitted.

MBE/WBE Replacement

When a Contractor has relied on a commitment to a MBE or WBE subcontractor (or an approved substitute MBE or WBE subcontractor) to meet all or part of a contract goal requirement, the contractor shall not terminate the MBE/WBE subcontractor or any portion of its work for convenience. This includes, but is not limited to, instances in which the Contractor seeks to perform the work of the terminated subcontractor with another MBE/WBE subcontractor, a non-MBE/WBE subcontractor, or with the Contractor's own forces or those of an affiliate.

The Contractor must give notice in writing both by certified mail and email to the MBE/WBE subcontractor, with a copy to the Engineer of its intent to request to terminate a MBE/WBE subcontractor or any portion of its work, and the reason for the request. The Contractor must give the MBE/WBE subcontractor five (5) business days to respond to the Contractor's Notice of Intent to Request Termination and/or Substitution. If the MBE/WBE subcontractor objects to the intended termination/substitution, the MBE/WBE, within five (5) business days must advise the Contractor and the Department of the reasons why the action should not be approved. The five-day notice period shall begin on the next business day after written notice is provided to the MBE/WBE subcontractor.

A committed MBE/WBE subcontractor may only be terminated or any portion of its work after receiving the Department's written approval based upon a finding of good cause for the proposed termination and/or substitution. Good cause does not exist if the Contractor seeks to terminate a MBE/WBE or any portion of its work that it relied upon to obtain the contract so that the Contractor can self-perform the work for which the MBE/WBE was engaged, or so that the Contractor can substitute another MBE/WBE or non-MBE/WBE contractor after contract award. For purposes of this section, good cause shall include the following circumstances:

- (a) The listed MBE/WBE subcontractor fails or refuses to execute a written contract;
- (b) The listed MBE/WBE subcontractor fails or refuses to perform the work of its subcontract in a way consistent with normal industry standards. Provided, however, that good cause does not exist if the failure or refusal of the MBE/WBE subcontractor to perform its work on the subcontract results from the bad faith or discriminatory action of the prime contractor;
- (c) The listed MBE/WBE subcontractor fails or refuses to meet the prime contractor's reasonable, nondiscriminatory bond requirements;
- (d) The listed MBE/WBE subcontractor becomes bankrupt, insolvent, or exhibits credit unworthiness;
- (e) The listed MBE/WBE subcontractor is ineligible to work on public works projects because of suspension and debarment proceedings pursuant to 2 CFR parts 180, 215 and 1200 or applicable State law;
- (f) The listed MBE/WBE subcontractor is not a responsible contractor;
- (g) The listed MBE/WBE voluntarily withdraws from the project and provides written notice of withdrawal;
- (h) The listed MBE/WBE is ineligible to receive MBE/WBE credit for the type of work required;
- (i) A MBE/WBE owner dies or becomes disabled with the result that the listed MBE/WBE contractor is unable to complete its work on the contract; and
- (j) Other documented good cause that compels the termination of the MBE/WBE subcontractor.

The Contractor shall comply with the following for replacement of a committed MBE/WBE:

(A) Performance Related Replacement

When a committed MBE/WBE is terminated for good cause as stated above, an additional MBE/WBE that was submitted at the time of bid may be used to fulfill the MBE/WBE commitment to meet the Combined MBE/WBE Goal. A good faith effort will only be required for removing a committed MBE/WBE if there were no additional MBE/WBEs submitted at the time of bid to cover the same amount of work as the MBE/WBE that was terminated.

If a replacement MBE/WBE is not found that can perform at least the same amount of work as the terminated MBE/WBE, the Contractor shall submit a good faith effort documenting the steps taken. Such documentation shall include, but not be limited to, the following:

- (1) Copies of written notification to MBE/WBEs that their interest is solicited in contracting the work defaulted by the previous MBE/WBE or in subcontracting other items of work in the contract.

- (2) Efforts to negotiate with MBE/WBEs for specific subbids including, at a minimum:
 - (a) The names, addresses, and telephone numbers of MBE/WBEs who were contacted.
 - (b) A description of the information provided to MBE/WBEs regarding the plans and specifications for portions of the work to be performed.
 - (3) A list of reasons why MBE/WBE quotes were not accepted.
 - (4) Efforts made to assist the MBE/WBEs contacted, if needed, in obtaining bonding or insurance required by the Contractor.
- (B) Decertification Replacement
- (1) When a committed MBE/WBE is decertified by the Department after the SAF (*Subcontract Approval Form*) has been received by the Department, the Department will not require the Contractor to solicit replacement MBE/WBE participation equal to the remaining work to be performed by the decertified firm. The participation equal to the remaining work performed by the decertified firm will count toward the contract goal requirement but not the overall goal.
 - (i) If the MBE/WBE's ineligibility is caused solely by its having exceeded the size standard during the performance of the contract. The Department may continue to count participation equal to the remaining work performed by the decertified firm which will count toward the contract goal requirement and overall goal.
 - (ii) If the MBE/WBE's ineligibility is caused solely by its acquisition by or merger with a non-MBE/WBE during the performance of the contract. The Department may not continue to count the portion of the decertified firm's performance on the contract remaining toward either the contract goal or the overall goal, even if the Contractor has executed a subcontract with the firm or the Department has executed a prime contract with the MBE/WBE that was later decertified.
 - (2) When a committed MBE/WBE is decertified prior to the Department receiving the SAF (*Subcontract Approval Form*) for the named MBE/WBE firm, the Contractor shall take all necessary and reasonable steps to replace the MBE/WBE subcontractor with another MBE/WBE subcontractor to perform at least the same amount of work to meet the Combined MBE/WBE goal requirement. If a MBE/WBE firm is not found to do the same amount of work, a good faith effort must be submitted to NCDOT (see A herein for required documentation).

All requests for replacement of a committed MBE/WBE firm shall be submitted to the Engineer for approval on Form RF-1 (*DBE Replacement Request*). If the Contractor fails to follow this procedure, the Contractor may be disqualified from further bidding for a period of up to 6 months.

Changes in the Work

When the Engineer makes changes that result in the reduction or elimination of work to be performed by a committed MBE/WBE, the Contractor will not be required to seek additional participation. When the Engineer makes changes that result in additional work to be performed by a MBE/WBE based upon the Contractor's commitment, the MBE/WBE shall participate in additional work to the same extent as the MBE/WBE participated in the original contract work.

When the Engineer makes changes that result in extra work, which has more than a minimal impact on the contract amount, the Contractor shall seek additional participation by MBEs/WBEs unless otherwise approved by the Engineer.

When the Engineer makes changes that result in an alteration of plans or details of construction, and a portion or all of the work had been expected to be performed by a committed MBE/WBE, the Contractor shall seek participation by MBEs/WBEs unless otherwise approved by the Engineer.

When the Contractor requests changes in the work that result in the reduction or elimination of work that the Contractor committed to be performed by a MBE/WBE, the Contractor shall seek additional participation by MBEs/WBEs equal to the reduced MBE/WBE participation caused by the changes.

Reports and Documentation

A SAF (*Subcontract Approval Form*) shall be submitted for all work which is to be performed by a MBE/WBE subcontractor. The Department reserves the right to require copies of actual subcontract agreements involving MBE/WBE subcontractors.

When using transportation services to meet the contract commitment, the Contractor shall submit a proposed trucking plan in addition to the SAF. The plan shall be submitted prior to beginning construction on the project. The plan shall include the names of all trucking firms proposed for use, their certification type(s), the number of trucks owned by the firm, as well as the individual truck identification numbers, and the line item(s) being performed.

Within 30 calendar days of entering into an agreement with a MBE/WBE for materials, supplies or services, not otherwise documented by the SAF as specified above, the Contractor shall furnish the Engineer a copy of the agreement. The documentation shall also indicate the percentage (60% or 100%) of expenditures claimed for MBE/WBE credit.

Reporting Minority and Women Business Enterprise Participation

The Contractor shall provide the Engineer with an accounting of payments made to all MBE and WBE firms, including material suppliers and contractors at all levels (prime, subcontractor, or second tier subcontractor). This accounting shall be furnished to the Engineer for any given month by the end of the following month. Failure to submit this information accordingly may result in the following action:

- (A) Withholding of money due in the next partial pay estimate; or
- (B) Removal of an approved contractor from the prequalified bidders' list or the removal of other entities from the approved subcontractors list.

While each contractor (prime, subcontractor, 2nd tier subcontractor) is responsible for accurate accounting of payments to MBEs/WBEs, it shall be the prime contractor's responsibility to report all monthly and final payment information in the correct reporting manner.

Failure on the part of the Contractor to submit the required information in the time frame specified may result in the disqualification of that contractor and any affiliate companies from further bidding until the required information is submitted.

Failure on the part of any subcontractor to submit the required information in the time frame specified may result in the disqualification of that contractor and any affiliate companies from being approved for further work on future projects until the required information is submitted.

Contractors reporting transportation services provided by non-MBE/WBE lessees shall evaluate the value of services provided during the month of the reporting period only.

At any time, the Engineer can request written verification of subcontractor payments.

The Contractor shall report the accounting of payments through the Department's DBE Payment Tracking System.

Failure to Meet Contract Requirements

Failure to meet contract requirements in accordance with Subarticle 102-15(J) of the *Standard Specifications* may be cause to disqualify the Contractor.

STANDARD SPECIAL PROVISIONS

AVAILABILITY OF FUNDS – TERMINATION OF CONTRACTS

(5-20-08)(Rev. 1-16-24)

Z-2

General Statute 143C-6-11. (h) Highway Appropriation is hereby incorporated verbatim in this contract as follows:

(h) Amounts Encumbered. – Transportation project appropriations may be encumbered in the amount of allotments made to the Department of Transportation by the Director for the estimated payments for transportation project contract work to be performed in the appropriation fiscal year. The allotments shall be multiyear allotments and shall be based on estimated revenues and shall be subject to the maximum contract authority contained in *General Statute 143C-6-11(c)*. Payment for transportation project work performed pursuant to contract in any fiscal year other than the current fiscal year is subject to appropriations by the General Assembly. Transportation project contracts shall contain a schedule of estimated completion progress, and any acceleration of this progress shall be subject to the approval of the Department of Transportation provided funds are available. The State reserves the right to terminate or suspend any transportation project contract, and any transportation project contract shall be so terminated or suspended if funds will not be available for payment of the work to be performed during that fiscal year pursuant to the contract. In the event of termination of any contract, the contractor shall be given a written notice of termination at least 60 days before completion of scheduled work for which funds are available. In the event of termination, the contractor shall be paid for the work already performed in accordance with the contract specifications.

Payment will be made on any contract terminated pursuant to the special provision in accordance with Subarticle 108-13(D) of the *Standard Specifications*.

AUTHORITY OF THE ENGINEER

The Engineer for this project shall be the Division Engineer, Division of Highways, North Carolina Department of Transportation, for the Division in which the project is located, acting directly for through his duly authorized representatives.

The Engineer will decide all questions which may arise as to the quality and acceptability of work performed and as to the rate of progress of the work; all questions which may arise as to the interpretation of the contract; and all questions as to the acceptable fulfillment of the contract on the part of the contractor. He shall have the authority to alter priorities in order to address special needs of the Department. His decision shall be final and he shall have executive authority to enforce and make effective such decisions and orders as the Contractor fail to carry out promptly.

MINIMUM WAGES

(7-21-09)

Z-5

FEDERAL: The Fair Labor Standards Act provides that with certain exceptions every employer shall pay wages at the rate of not less than SEVEN DOLLARS AND TWENTY FIVE CENTS (\$7.25) per hour.

STATE: The North Carolina Minimum Wage Act provides that every employer shall pay to each of his employees, wages at a rate of not less than SEVEN DOLLARS AND TWENTY FIVE CENTS (\$7.25) per hour.

The minimum wage paid to all skilled labor employed on this contract shall be SEVEN DOLLARS AND TWENTY FIVE CENTS (\$7.25) per hour.

The minimum wage paid to all intermediate labor employed on this contract shall be SEVEN DOLLARS AND TWENTY FIVE CENTS (\$7.25) per hour.

The minimum wage paid to all unskilled labor on this contract shall be SEVEN DOLLARS AND TWENTY FIVE CENTS (\$7.25) per hour.

This determination of the intent of the application of this act to the contract on this project is the responsibility of the Contractor.

The Contractor shall have no claim against the Department of Transportation for any changes in the minimum wage laws, Federal or State. It is the responsibility of the Contractor to keep fully informed of all Federal and State Laws affecting his contract.

EROSION CONTROL

The Contractor shall exercise every reasonable precaution throughout the life of the project to prevent erosion and siltation.

WORK ZONE SIGNING

(10-21-08)

RWZ-3

Description

Install and maintain signing in accordance with Divisions 11 and 12 of the *Standard Specifications*, the *Roadway Standard Drawings* and the following provisions:

The Contractor shall be responsible for all signs and signing.

PLANT AND PEST QUARANTINES

(Imported Fire Ant, Gypsy Moth, Witchweed, Emerald Ash Borer, And Other Noxious Weeds)

(3-18-03) (Rev. 12-20-16)

Z-04a

Within Quarantined Area

This project may be within a county regulated for plant and/or pests. If the project or any part of the Contractor's operations is located within a quarantined area, thoroughly clean all equipment prior to moving out of the quarantined area. Comply with federal/state regulations by obtaining a certificate or limited permit for any regulated article moving from the quarantined area.

Originating in a Quarantined County

Obtain a certificate or limited permit issued by the N.C. Department of Agriculture/United States Department of Agriculture. Have the certificate or limited permit accompany the article when it arrives at the project site.

Contact

Contact the N.C. Department of Agriculture/United States Department of Agriculture at 1-800-206-9333, 919-707-3730, or <http://www.ncagr.gov/plantindustry/> to determine those specific project sites located in the quarantined area or for any regulated article used on this project originating in a quarantined county.

Regulated Articles Include

1. Soil, sand, gravel, compost, peat, humus, muck, and decomposed manure, separately or with other articles. This includes movement of articles listed above that may be associated with cut/waste, ditch pulling, and shoulder cutting.
2. Plants with roots including grass sod.
3. Plant crowns and roots.
4. Bulbs, corms, rhizomes, and tubers of ornamental plants.
5. Hay, straw, fodder, and plant litter of any kind.
6. Clearing and grubbing debris.
7. Used agricultural cultivating and harvesting equipment.
8. Used earth-moving equipment.
9. Any other products, articles, or means of conveyance, of any character, if determined by an inspector to present a hazard of spreading imported fire ant, gypsy moth, witchweed, emerald ash borer, or other noxious weeds.

BANKRUPTCY

The Department of Transportation, at its option, may terminate the contract upon filing by the Contractor of any petition for protection under the provisions of the Federal Bankruptcy Act.

SUBLETTING OF CONTRACT

If a Contractor desires to sublet any work, written consent must be given by the Engineer. The approval of any subcontract will not release the Contractor of liability under the contract, nor will the subcontractor or the second tier subcontractor have any claim against NCDOT by reason of the approval of the subcontract.

DEBARMENT STATEMENT

The Contractor certifies and understands that by his/her signature on the Bid Form that he/she and the contracting firm he/she represents has not been banned, debarred, suspended, proposed for debarment, or declared ineligible for the award of contracts by any Federal agency.

DEFAULT OF CONTRACT

The Department of Transportation shall have the right to declare a default of contract for breach by the Contractor of any material term or condition of the contract. Default of contract shall be in accordance with the terms, conditions, and procedures of Article 108-9 of the Standard Specifications.

COOPERATION BETWEEN CONTRACTORS

The Department reserves the right at any time to contract for and perform other or additional work on or near the work covered by the contract. When separate or additional contracts are let within the limits of any one project, each Contractor shall conduct his work so as not to interfere with or hinder the progress or completion of the work being performed by other Contractors. Contractors working within the limits of the same project shall cooperate with each other. Each Contractor shall conduct his operations in such a manner as to avoid damaging any work being performed by others or which others have completed.

NO MAJOR CONTRACT ITEMS

None of the items included in this contract will be major items.

NO SPECIALTY ITEMS:

(7-1-95)(Rev. 1-16-24)

108-6

SP1 G34

None of the items included in this contract will be specialty items (see Article 108-6 of the *Standard Specifications*).

UTILITY CONFLICTS

Special care shall be used in working around or near existing utilities, protecting them when necessary to provide uninterrupted service. In the event that any utility service is interrupted, the Contractor shall notify the utility owner immediately and shall cooperate with the owner, or his representative, in the restoration of service in the shortest time possible. Existing fire hydrants shall be kept accessible to fire departments at all times.

The Contractor shall adhere to all applicable regulations and follow accepted safety procedures when working in the vicinity of utilities in order to insure the safety of construction personnel and the public.

DRIVEWAYS AND PRIVATE PROPERTY

The Contractor shall maintain access to driveways for all residents, businesses, and property owners throughout the life of the project. The Contractor shall not perform work for private citizens or agencies in conjunction with this project or within the project limits of this contract.

OUTSOURCING OUTSIDE THE USA

All work on consultant contracts, services contracts, and construction contracts shall be performed in the United States of America. No work shall be outsourced outside of the United States of America.

Outsourcing for the purpose of this provision is defined as the practice of subcontracting labor, work, services, staffing, or personnel to entities located outside of the United States.

The North Carolina Secretary of Transportation shall approve exceptions to this provision in writing.

TITLE VI AND NONDISCRIMINATION:

(6-28-77)(Rev 1/16/2024)

Z-6

The North Carolina Department of Transportation is committed to carrying out the U.S. Department of Transportation's policy of ensuring nondiscrimination in the award and administration of contracts.

The provisions of this section related to United States Department of Transportation (US DOT) Order 1050.2A, Title 49 Code of Federal Regulations (CFR) part 21, 23 United States Code (U.S.C.) 140 and 23 CFR part 200 (or 49 CFR 303, 49 U.S.C. 5332 or 49 U.S.C. 47123) are applicable to all North Carolina Department of Transportation (NCDOT) contracts and to all related subcontracts, material supply, engineering, architectural and other service contracts, regardless of dollar amount. Any Federal provision that is specifically required not specifically set forth is hereby incorporated by reference.

(1) Title VI Assurances (USDOT Order 1050.2A, Appendix A)

During the performance of this contract, the contractor, for itself, its assignees, and successors in interest (hereinafter referred to as the "contractor") agrees as follows:

(a) Compliance with Regulations

The contractor (hereinafter includes consultants) shall comply with the Acts and the Regulations relative to Nondiscrimination in Federally-assisted programs of the U.S. Department of Transportation, Federal Highway Administration (FHWA), as they may be amended from time to time, which are herein incorporated by reference and made a part of this contract.

(b) Nondiscrimination

The contractor, with regard to the work performed by it during the contract, shall not discriminate on the grounds of race, color, or national origin in the selection and retention of subcontractors, including procurements of materials and leases of equipment. The contractor shall not participate directly or indirectly in the discrimination prohibited by the Acts and the Regulations, including employment practices when the contract covers any activity, project, or program set forth in Appendix B of 49 CFR Part 21.

(c) Solicitations for Subcontractors, Including Procurements of Materials and Equipment

In all solicitations, either by competitive bidding, or negotiation made by the contractor for work to be performed under a subcontract, including procurements of materials, or leases of equipment, each potential subcontractor or supplier shall be notified by the contractor of the contractor's obligations under this contract and the Acts and the Regulations relative to Nondiscrimination on the grounds of race, color, or national origin.

(d) Information and Reports

The contractor shall provide all information and reports required by the Acts, the Regulations, and directives issued pursuant thereto and shall permit access to its books, records, accounts, other sources of information, and its facilities as may be determined by the Recipient or the FHWA to be pertinent to ascertain compliance with such Acts, Regulations, and instructions. Where any information required of a contractor is in the exclusive possession of another who fails or refuses to furnish the information, the contractor shall so certify to the Recipient or the FHWA, as appropriate, and shall set forth what efforts it has made to obtain the information.

(e) Sanctions for Noncompliance:

In the event of a contractor's noncompliance with the Non-discrimination provisions of this contract, the Recipient will impose such contract sanctions as it and/or the FHWA may determine to be appropriate, including, but not limited to:

- (i) Withholding payments to the contractor under the contract until the contractor complies; and/or
- (ii) Cancelling, terminating, or suspending a contract, in whole or in part.

(f) Incorporation of Provisions

The contractor shall include the provisions of paragraphs (a) through (f) in every subcontract, including procurements of materials and leases of equipment, unless exempt by the Acts, the Regulations and directives issued pursuant thereto. The contractor shall take action with respect to any subcontract or procurement as the Recipient or the FHWA may direct as a means of enforcing such provisions including sanctions for noncompliance. Provided, that if the contractor becomes involved in, or is threatened with litigation by a subcontractor, or supplier because of such direction, the contractor may request the Recipient to enter into any litigation to protect the interests of the Recipient. In addition, the contractor may request the United States to enter into the litigation to protect the interests of the United States.

(2) Title VI Nondiscrimination Program (23 CFR 200.5(p))

The North Carolina Department of Transportation (NCDOT) has assured the USDOT that, as a condition to receiving federal financial assistance, NCDOT will comply with Title VI of the Civil Rights Act of 1964 and all requirements imposed by Title 49 CFR part 21 and related nondiscrimination authorities to ensure that no person shall, on the ground of race, color, national origin, limited English proficiency, sex, age, or disability (including religion/creed or income-level, where applicable), be excluded from participation in, be denied the benefits of, or be subjected to discrimination under any programs, activities, or services conducted or funded by NCDOT. Contractors and other organizations under contract or agreement with NCDOT must also comply with Title VI and related authorities, therefore:

- (a) During the performance of this contract or agreement, contractors (e.g., subcontractors, consultants, vendors, prime contractors) are responsible for complying with NCDOT's Title VI Program. Contractors are not required to prepare or submit Title VI Programs. To comply with this section, the prime contractor shall:

1. Post NCDOT's Notice of Nondiscrimination and the Contractor's own Equal Employment Opportunity (EEO) Policy in conspicuous locations accessible to all employees, applicants and subcontractors on the jobsite.
2. Physically incorporate the required Title VI clauses into all subcontracts on federally-assisted and state-funded NCDOT projects, and ensure inclusion by subcontractors into all lower-tier subcontracts.
3. Required Solicitation Language. The Contractor shall include the following notification in all solicitations for bids and requests for work or material, regardless of funding source:

"The North Carolina Department of Transportation, in accordance with the provisions of Title VI of the Civil Rights Act of 1964 (78 Stat. 252, 42 US.C. §§ 2000d to 2000d-4) and the Regulations, hereby notifies all bidders that it will affirmatively ensure that any contract entered into pursuant to this advertisement, disadvantaged business enterprises will be afforded full and fair opportunity to submit bids in response to this invitation and will not be discriminated against on the grounds of

race, color, or national origin in consideration for an award. In accordance with other related nondiscrimination authorities, bidders and contractors will also not be discriminated against on the grounds of sex, age, disability, low-income level, creed/religion, or limited English proficiency in consideration for an award.”

4. Physically incorporate the FHWA-1273, in its entirety, into all subcontracts and subsequent lower tier subcontracts on Federal-aid highway construction contracts only.
 5. Provide language assistance services (i.e., written translation and oral interpretation), free of charge, to LEP employees and applicants. Contact NCDOT OCR for further assistance, if needed.
 6. For assistance with these Title VI requirements, contact the NCDOT Title VI Nondiscrimination Program at 1-800-522-0453.
- (b) Subrecipients (e.g. cities, counties, LGAs, planning organizations) may be required to prepare and submit a Title VI Plan to NCDOT, including Title VI Assurances and/or agreements. Subrecipients must also ensure compliance by their contractors and subrecipients with Title VI. (23 CFR 200.9(b)(7))
- (c) If reviewed or investigated by NCDOT, the contractor or subrecipient agrees to take affirmative action to correct any deficiencies found within a reasonable time period, not to exceed 90 calendar days, unless additional time is granted by NCDOT. (23 CFR 200.9(b)(15))
- (d) The Contractor is responsible for notifying subcontractors of NCDOT’s External Discrimination Complaints Process.

1. Applicability

Title VI and related laws protect participants and beneficiaries (e.g., members of the public and contractors) from discrimination by NCDOT employees, subrecipients and contractors, regardless of funding source.

2. Eligibility

Any person—or class of persons—who believes he/she has been subjected to discrimination based on race, color, national origin, Limited English Proficiency (LEP), sex, age, or disability (and religion in the context of employment, aviation, or transit) may file a written complaint. The law also prohibits intimidation or retaliation of any sort.

3. Time Limits and Filing Options

Complaints may be filed by the affected individual(s) or a representative and must be filed no later than 180 calendar days after the following:

- (i) The date of the alleged act of discrimination; or
- (ii) The date when the person(s) became aware of the alleged discrimination; or
- (iii) Where there has been a continuing course of conduct, the date on which that conduct was discontinued or the latest instance of the conduct.

Title VI and related discrimination complaints may be submitted to the following entities:

- North Carolina Department of Transportation, Office of Civil Rights, Title VI Program, 1511 Mail Service Center, Raleigh, NC 27699-1511; toll free 1-800-522-0453
- Federal Highway Administration, North Carolina Division Office, 310 New Bern Avenue, Suite 410, Raleigh, NC 27601, 919-747-7010
- US Department of Transportation, Departmental Office of Civil Rights, External Civil Rights Programs Division, 1200 New Jersey Avenue, SE, Washington, DC 20590; 202-366-4070

4. Format for Complaints

Complaints must be in writing and signed by the complainant(s) or a representative, and include the complainant’s name, address, and telephone number. Complaints received by fax or e-mail will be acknowledged and processed. Allegations received by telephone will be reduced to writing and provided to the complainant for confirmation or revision before processing. Complaints will be accepted in other languages, including Braille.

5. Discrimination Complaint Form

Contact NCDOT Civil Rights to receive a full copy of the Discrimination Complaint Form and procedures.

6. Complaint Basis

Allegations must be based on issues involving race, color, national origin (LEP), sex, age, disability, or religion (in the context of employment, aviation or transit). “Basis” refers to the complainant’s membership in a protected group category.

**TABLE 103-1
COMPLAINT BASIS**

Protected Categories	Definition	Examples	Applicable Nondiscrimination Authorities
Race and Ethnicity	An individual belonging to one of the accepted racial groups; or the perception, based usually on physical characteristics that a person is a member of a racial group	Black/African American, Hispanic/Latino, Asian, American Indian/Alaska Native, Native Hawaiian/Pacific Islander, White	Title VI of the Civil Rights Act of 1964; 49 CFR Part 21; 23 CFR 200; 49 U.S.C. 5332(b); 49 U.S.C. 47123. <i>(Executive Order 13166)</i>
Color	Color of skin, including shade of skin within a racial group	Black, White, brown, yellow, etc.	
National Origin <i>(Limited English Proficiency)</i>	Place of birth. Citizenship is not a factor. <i>(Discrimination based on language or a person’s accent is also covered)</i>	Mexican, Cuban, Japanese, Vietnamese, Chinese	
Sex	Gender. The sex of an individual. <i>Note: Sex under this program does not include sexual orientation.</i>	Women and Men	1973 Federal-Aid Highway Act; 49 U.S.C. 5332(b); 49 U.S.C. 47123.
Age	Persons of any age	21-year-old person	Age Discrimination Act of 1975 49 U.S.C. 5332(b); 49 U.S.C. 47123.
Disability	Physical or mental impairment, permanent or temporary, or perceived.	Blind, alcoholic, para-amputee, epileptic, diabetic, arthritic	Section 504 of the Rehabilitation Act of 1973; Americans with Disabilities Act of 1990

<p>Religion (in the context of employment) <i>(Religion/ Creed in all aspects of any aviation or transit-related construction)</i></p>	<p>An individual belonging to a religious group; or the perception, based on distinguishable characteristics that a person is a member of a religious group. In practice, actions taken as a result of the moral and ethical beliefs as to what is right and wrong, which are sincerely held with the strength of traditional religious views. Note: Does not have to be associated with a recognized religious group or church; if an individual sincerely holds to the belief, it is a protected religious practice.</p>	<p>Muslim, Christian, Sikh, Hindu, etc.</p>	<p>Title VII of the Civil Rights Act of 1964; 23 CFR 230; FHWA-1273 Required Contract Provisions. <i>(49 U.S.C. 5332(b); 49 U.S.C. 47123)</i></p>
--	---	---	---

(3) Pertinent Nondiscrimination Authorities

During the performance of this contract, the contractor, for itself, its assignees, and successors in interest agrees to comply with the following non-discrimination statutes and authorities, including, but not limited to:

- Title VI of the Civil Rights Act of 1964 (42 U.S.C. § 2000d et seq., 78 stat. 252), (prohibits discrimination on the basis of race, color, national origin); and 49 CFR Part 21.
- The Uniform Relocation Assistance and Real Property Acquisition Policies Act of 1970, (42 U.S.C. § 4601), (prohibits unfair treatment of persons displaced or whose property has been acquired because of Federal or Federal-aid programs and projects);
- Federal-Aid Highway Act of 1973, (23 U.S.C. § 324 et seq.), (prohibits discrimination on the basis of sex);
- Section 504 of the Rehabilitation Act of 1973, (29 U.S.C. § 794 et seq.), as amended, (prohibits discrimination on the basis of disability) and 49 CFR Part 27;
- The Age Discrimination Act of 1975, as amended, (42 U.S.C. § 6101 et seq.), (prohibits discrimination on the basis of age);
- Airport and Airway Improvement Act of 1982, (49 USC § 471, Section 47123), as amended, (prohibits discrimination based on race, creed, color, national origin, or sex);
- (g) The Civil Rights Restoration Act of 1987, (PL 100-209), (Broadened the scope, coverage and applicability of Title VI of the Civil Rights Act of 1964, The Age Discrimination Act of 1975 and Section 504 of the Rehabilitation Act of 1973, by expanding the definition of the terms "programs or activities" to include all of the programs or activities of the Federal-aid recipients, sub-recipients and contractors, whether such programs or activities are Federally funded or not);
- (h) Titles II and III of the Americans with Disabilities Act, which prohibit discrimination on the basis of disability in the operation of public entities, public and private transportation systems, places of public accommodation, and certain testing entities (42 U.S.C. §§ 12131-12189) as implemented by Department of Transportation regulations at 49 C.F.R. parts 37 and 38;
- (i) The Federal Aviation Administration's Nondiscrimination statute (49 U.S.C. § 47123) (prohibits discrimination on the basis of race, color, national origin, and sex);

- (j) Executive Order 12898, Federal Actions to Address Environmental Justice in Minority Populations and Low-Income Populations, which ensures Nondiscrimination against minority populations by discouraging programs, policies, and activities with disproportionately high and adverse human health or environmental effects on minority and low-income populations;
- (k) Executive Order 13166, Improving Access to Services for Persons with Limited English Proficiency, and resulting agency guidance, national origin discrimination includes discrimination because of Limited English proficiency (LEP). To ensure compliance with Title VI, you must take reasonable steps to ensure that LEP persons have meaningful access to your programs (70 Fed. Reg. at 74087 to 74100);
- (l) Title IX of the Education Amendments of 1972, as amended, which prohibits you from discriminating because of sex in education programs or activities (20 U.S.C. 1681 et seq).
- (m) Title VII of the Civil Rights Act of 1964 (42 U.S.C. § 2000e et seq., Pub. L. 88-352), (prohibits employment discrimination on the basis of race, color, religion, sex, or national origin).

(4) Additional Title VI Assurances

***The following Title VI Assurances (Appendices B, C and D) shall apply, as applicable*

(a) Clauses for Deeds Transferring United States Property (1050.2A, Appendix B)

The following clauses will be included in deeds effecting or recording the transfer of real property, structures, or improvements thereon, or granting interest therein from the United States pursuant to the provisions of Assurance 4.

NOW, THEREFORE, the U.S. Department of Transportation as authorized by law and upon the condition that the North Carolina Department of Transportation (NCDOT) will accept title to the lands and maintain the project constructed thereon in accordance with the North Carolina General Assembly, the Regulations for the Administration of the Federal-Aid Highway Program, and the policies and procedures prescribed by the Federal Highway Administration of the U.S. Department of Transportation in accordance and in compliance with all requirements imposed by Title 49, Code of Federal Regulations, U.S. Department of Transportation, Subtitle A, Office of the Secretary, Part 21, Nondiscrimination in Federally-assisted programs of the U.S Department of Transportation pertaining to and effectuating the provisions of Title VI of the Civil Rights Act of 1964 (78 Stat. 252; 42 U.S.C. § 2000d to 2000d-4), does hereby remise, release, quitclaim and convey unto the NCDOT all the right, title and interest of the U.S. Department of Transportation in and to said lands described in Exhibit A attached hereto and made a part hereof.

(HABENDUM CLAUSE)

TO HAVE AND TO HOLD said lands and interests therein unto the North Carolina Department of Transportation (NCDOT) and its successors forever, subject, however, to the covenants, conditions, restrictions and reservations herein contained as follows, which will remain in effect for the period during which the real property or structures are used for a purpose for which Federal financial assistance is extended or for another purpose involving the provision of similar services or benefits and will be binding on the NCDOT, its successors and assigns.

The NCDOT, in consideration of the conveyance of said lands and interests in lands, does hereby covenant and agree as a covenant running with the land for itself, its successors and assigns, that (1) no person will on the grounds of race, color, or national origin, be excluded from participation in, be denied the benefits of, or be otherwise subjected to discrimination with regard to any facility located wholly or in part on, over, or under such lands hereby conveyed [,] [and]* (2) that the NCDOT will use the lands and interests in lands and interests in lands so conveyed, in compliance with all requirements imposed by or pursuant to Title 49, Code of Federal Regulations, U.S. Department of Transportation, Subtitle A, Office of the Secretary, Part 21, Non-discrimination in Federally-assisted programs of the U.S. Department of Transportation, Effectuation of Title VI of the Civil Rights Act of 1964, and as said Regulations and Acts may be amended [, and (3) that in the event of breach of any of the above-mentioned nondiscrimination conditions, the Department will have a right to enter or re-enter said lands and facilities on said land, and that above described land and facilities will thereon revert to and vest in and become the absolute property of the U.S. Department of Transportation and its assigns as such interest existed prior to this instruction].*

(*Reverter clause and related language to be used only when it is determined that such a clause is necessary in order to make clear the purpose of Title VI.)

(b) Clauses for Transfer of Real Property Acquired or Improved Under the Activity, Facility, or Program (1050.2A, Appendix C)

The following clauses will be included in deeds, licenses, leases, permits, or similar instruments entered into by the North Carolina Department of Transportation (NCDOT) pursuant to the provisions of Assurance 7(a):

1. The (grantee, lessee, permittee, etc. as appropriate) for himself/herself, his/her heirs, personal representatives, successors in interest, and assigns, as a part of the consideration hereof, does hereby covenant and agree [in the case of deeds and leases add "as a covenant running with the land"] that:
 - (i.) In the event facilities are constructed, maintained, or otherwise operated on the property described in this (deed, license, lease, permit, etc.) for a purpose for which a U.S. Department of Transportation activity, facility, or program is extended or for another purpose involving the provision of similar services or benefits, the (grantee, licensee, lessee, permittee, etc.) will maintain and operate such facilities and services in compliance with all requirements imposed by the Acts and Regulations (as may be amended) such that no person on the grounds of race, color, or national origin, will be excluded from participation in, denied the benefits of, or be otherwise subjected to discrimination in the use of said facilities.
2. With respect to licenses, leases, permits, etc., in the event of breach of any of the above Nondiscrimination covenants, the NCDOT will have the right to terminate the (lease, license, permit, etc.) and to enter, re-enter, and repossess said lands and facilities thereon, and hold the same as if the (lease, license, permit, etc.) had never been made or issued. *
3. With respect to a deed, in the event of breach of any of the above Nondiscrimination covenants, the NCDOT will have the right to enter or re-enter the lands and facilities thereon, and the above described lands and facilities will there upon revert to and vest in and become the absolute property of the NCDOT and its assigns. *

(*Reverter clause and related language to be used only when it is determined that such a clause is necessary in order to make clear the purpose of Title VI.)

(c) Clauses for Construction/Use/Access to Real Property Acquired Under the Activity, Facility or Program (1050.2A, Appendix D)

The following clauses will be included in deeds, licenses, permits, or similar instruments/ agreements entered into by the North Carolina Department of Transportation (NCDOT) pursuant to the provisions of Assurance 7(b):

1. The (grantee, licensee, permittee, etc., as appropriate) for himself/herself, his/her heirs, personal representatives, successors in interest, and assigns, as a part of the consideration hereof, does hereby covenant and agree (in the case of deeds and leases add, "as a covenant running with the land") that (1) no person on the ground of race, color, or national origin, will be excluded from participation in, denied the benefits of, or be otherwise subjected to discrimination in the use of said facilities, (2) that in the construction of any improvements on, over, or under such land, and the furnishing of services thereon, no person on the ground of race, color, or national origin, will be excluded from participation in, denied the benefits of, or otherwise be subjected to discrimination, (3) that the (grantee, licensee, lessee, permittee, etc.) will use the premises in compliance with all other requirements imposed by or pursuant to the Acts and Regulations, as amended, set forth in this Assurance.
2. With respect to (licenses, leases, permits, etc.), in the event of breach of any of the above Non-discrimination covenants, the NCDOT will have the right to terminate the (license, permit, etc., as appropriate) and to enter or re-enter and repossess said land and the facilities thereon, and hold the same as if said (license, permit, etc., as appropriate) had never been made or issued. *
3. With respect to deeds, in the event of breach of any of the above Nondiscrimination covenants, the NCDOT will there upon revert to and vest in and become the absolute property of the NCDOT and its assigns. *

(*Reverter clause and related language to be used only when it is determined that such a clause is necessary to make clear the purpose of Title VI.)

APPENDIX

WORK ZONE TRAFFIC CONTROL GUIDANCE FOR LITTER/DEBRIS REMOVAL

The Contractor performing Work Zone Traffic Control shall have a minimum of one (1) NCDOT Certified Work Zone Supervisor.

GENERAL

- Workers that are involved in litter/debris removal operations shall comply with the following:
 - Wear NCDOT approved safety vests for day time operations
- Litter/debris removal operations shall be confined within a maximum 5 mile stretch of roadway in a work period
- Conduct litter/debris removal operations behind lane closures at any location where workers and/or equipment are encroaching into the travel lanes. Lane closures shall be installed according to Roadway Standard Drawings 1101.02. Encroaching into travel lanes includes exiting and entering vehicles that are parked on shoulders.
- Use the following drawings to retrieve bagged litter/debris and any other materials after being collected by the workers.
- For operations where workers and equipment are confined to the shoulders, comply with the followings:

On Multilane Divided Facilities

- A Truck Mounted Attenuator (TMA) shall be used to protect each group of workers removing litter/debris if the shoulder is wide enough to fit a TMA.
- If a TMA is not used, a shoulder closure shall be installed
- A shoulder closure shall be installed in locations where the shoulder is too narrow to accommodate a TMA without encroaching into the traffic lane
- A shoulder closure or a TMA shall be used on the median side of the opposite direction if the following condition exists:
 - Where workers and/or equipment are within 15' from the adjacent travel lane in the opposite direction and are not protected from traffic in the opposite direction by any type of positive median protection such as concrete barrier, guardrail, or guiderail.
- Shoulder closures shall be installed according to Roadway Standard Drawing 1101.04

Two-Lane, Two-Way Facilities over 4000 ADT

- A shoulder closure shall be installed if workers are to be present more than one hour at any location.
- If workers are to be present less than one hour, use portable advance warning signs (one in each direction) reading "LITTER PICKUP AHEAD".
- Shoulder closures shall be installed according to Roadway Standard Drawing 1101.04

Two-Lane, Two-Way Facilities 4000 ADT or lower

- Use portable advance warning signs (one in each direction) reading "LITTER PICKUP AHEAD". The sign should be located 500 feet ahead of the area where workers and or equipment will be present during the operation.

PLEASE NOTE THE FOLLOWING EXCEPTIONS:

The moving caravan operation will NOT be required to be used while retrieving bagged litter/debris in areas where the Contractor's equipment is able to traverse the shoulder without encroaching into the travel lanes.

The truck mounted attenuator (TMA) will NOT be required to be used while retrieving bagged litter/debris in areas where the Contractor's equipment is able to traverse the shoulder without encroaching into the travel lanes.

If the vehicle the Contractor is using is wider than the width of the shoulder a moving caravan operation WILL be required if the Contractor elects to allow the vehicle to encroach into the travel.

The Contractor may elect to park the vehicle outside of these narrow areas and remove bags by hand in lieu of the moving caravan operation.

The truck mounted attenuator (TMA) will NOT be required to protect workers picking up litter/debris if the Contractor's operations are carried out in such a way that the workers are positioned individually along a roadway and not travelling in a concentrated group.

If a concentrated group of workers are gathered together in a formation to conduct clean up then they shall be protected by a TMA.

The shoulder closure will NOT be required unless equipment remains stationary for more than 5 minutes and/or a concentrated group of workers are within 15 feet of an open travel lane and the area is not protected by barrier or guardrail.

The lane closure will NOT be required unless equipment remains stationary for more than five minutes and/or a concentrated group of workers are within 10 feet of an open travel lane and the area is not protected by barrier or guardrail."

A concentrated group of workers is defined as three (3) or more workers within a 500' section and within fifteen (15) feet from a travel lane, measured along the edge of the roadway, of other workers.

WORK ZONE SIGNING:

All portable signs and stands must meet or exceed the requirements of the National Cooperative Highway Research Program Report 350 for Work Zone Category II Devices, and be listed on North Carolina's approved products list or accepted as traffic qualified by the Traffic Control Section. Use portable work zone signs and stands specifically designed for one another.

Refer to the following:

- SSRS 1089 for material specification
- SSRS 1110 for construction specification
- RSD 1110 for clearance specification

The W10-10A shall be used for high volume primary and secondary routes. Its dimensions are 48" X 48". It shall be mounted at a minimum height of five (5) feet above the elevation of the outermost edge of travel. The sign shall read "LITTER PICKUP AHEAD", and should be relocated accordingly during the prosecution of work. Additional signs may be required by the Engineer at interchanges.

Sign Detail for Litter/Debris Removal Vehicle

**DETAIL OF SIGN TO BE MOUNTED
ON BACK OF ALL VEHICLES USED FOR
LITTER/DEBRIS REMOVAL**

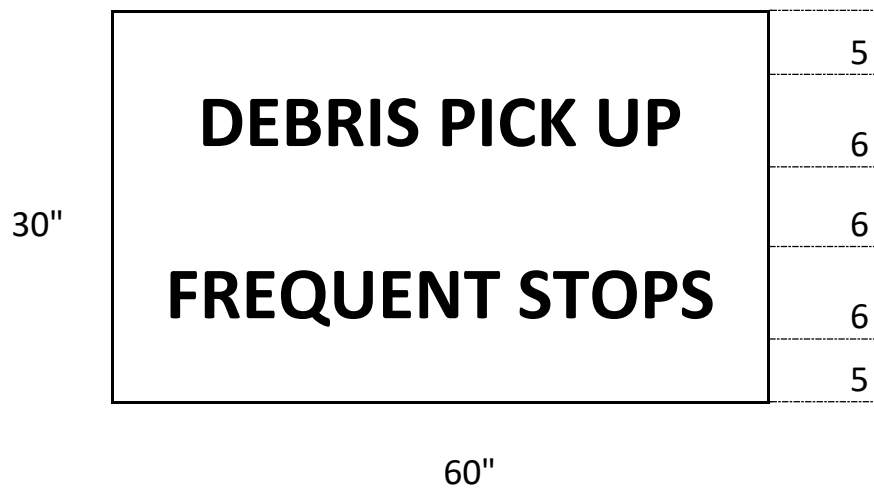

Lettering -
Black

Background - Fluorescent Orange (Retroreflective)

Service Vehicles

<p style="text-align: center;">STATE OF NORTH CAROLINA DEPT. OF TRANSPORTATION DIVISION OF HIGHWAYS RALEIGH, N.C.</p> <p style="text-align: right;">1-12</p>	<p style="text-align: center;">ENGLISH STANDARD DRAWING FOR WORK VEHICLE LIGHTING SYSTEMS AND TMA DELINEATION</p>
<p style="text-align: center;">STATE OF NORTH CAROLINA DEPT. OF TRANSPORTATION DIVISION OF HIGHWAYS RALEIGH, N.C.</p> <p style="text-align: right;">1-12</p>	<p style="text-align: center;">ENGLISH STANDARD DRAWING FOR WORK VEHICLE LIGHTING SYSTEMS AND TMA DELINEATION</p>
<p style="text-align: center;">STATE OF NORTH CAROLINA DEPT. OF TRANSPORTATION DIVISION OF HIGHWAYS RALEIGH, N.C.</p> <p style="text-align: right;">1-12</p>	<p style="text-align: center;">ENGLISH STANDARD DRAWING FOR WORK VEHICLE LIGHTING SYSTEMS AND TMA DELINEATION</p>
<p style="text-align: center;">STATE OF NORTH CAROLINA DEPT. OF TRANSPORTATION DIVISION OF HIGHWAYS RALEIGH, N.C.</p> <p style="text-align: right;">1-12</p>	<p style="text-align: center;">ENGLISH STANDARD DRAWING FOR WORK VEHICLE LIGHTING SYSTEMS AND TMA DELINEATION</p>

STATE OF
NORTH CAROLINA
DEPT. OF TRANSPORTATION
DIVISION OF HIGHWAYS
RALEIGH, N.C.

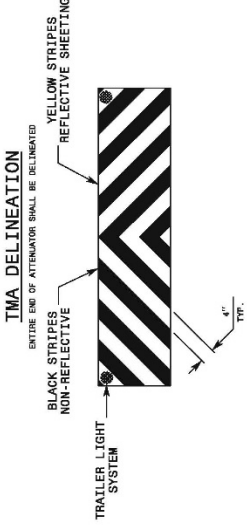

STATE OF
NORTH CAROLINA
DEPT. OF TRANSPORTATION
DIVISION OF HIGHWAYS
RALEIGH, N.C.

1-12

STATE OF
NORTH CAROLINA
DEPT. OF TRANSPORTATION
DIVISION OF HIGHWAYS
RALEIGH, N.C.

1-12

STATE OF
NORTH CAROLINA
DEPT. OF TRANSPORTATION
DIVISION OF HIGHWAYS
RALEIGH, N.C.

1-12

ENGLISH STANDARD DRAWING FOR
**WORK VEHICLE LIGHTING SYSTEMS
AND TMA DELINEATION**

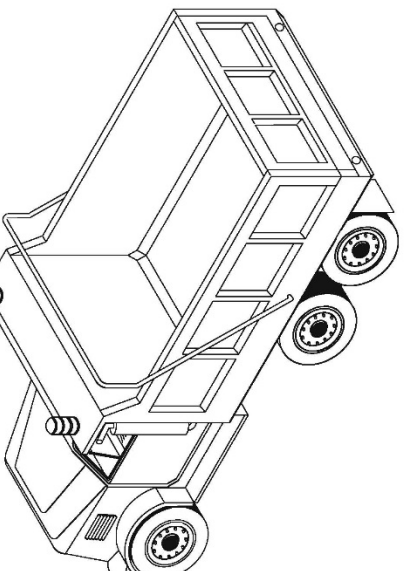
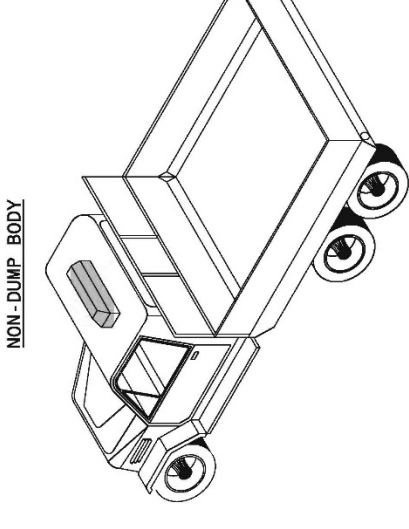

ENGLISH STANDARD DRAWING FOR
**WORK VEHICLE LIGHTING SYSTEMS
AND TMA DELINEATION**

ENGLISH STANDARD DRAWING FOR
**WORK VEHICLE LIGHTING SYSTEMS
AND TMA DELINEATION**

ENGLISH STANDARD DRAWING FOR
**WORK VEHICLE LIGHTING SYSTEMS
AND TMA DELINEATION**

ENGLISH STANDARD DRAWING FOR
**WORK VEHICLE LIGHTING SYSTEMS
AND TMA DELINEATION**

ENGLISH STANDARD DRAWING FOR
**WORK VEHICLE LIGHTING SYSTEMS
AND TMA DELINEATION**

ENGLISH STANDARD DRAWING FOR
**WORK VEHICLE LIGHTING SYSTEMS
AND TMA DELINEATION**

ENGLISH STANDARD DRAWING FOR
**WORK VEHICLE LIGHTING SYSTEMS
AND TMA DELINEATION**

ENGLISH STANDARD DRAWING FOR
**WORK VEHICLE LIGHTING SYSTEMS
AND TMA DELINEATION**

ENGLISH STANDARD DRAWING FOR
**WORK VEHICLE LIGHTING SYSTEMS
AND TMA DELINEATION**

ENGLISH STANDARD DRAWING FOR
**WORK VEHICLE LIGHTING SYSTEMS
AND TMA DELINEATION**

ENGLISH STANDARD DRAWING FOR
**WORK VEHICLE LIGHTING SYSTEMS
AND TMA DELINEATION**

ENGLISH STANDARD DRAWING FOR
**WORK VEHICLE LIGHTING SYSTEMS
AND TMA DELINEATION**

GENERAL NOTES FOR TMA REQUIREMENTS

- 1- WHEN TMA'S USED FOR SHADOW VEHICLES, CONTACT THE TMA MANUFACTURER FOR SPECIFIC TRUCK REQUIREMENTS.
- 2- TMA MUST MEET OR EXCEED THE REQUIREMENTS OF MOTOR VEH. TEST LEVEL II FOR WORK ZONES WITH POSTED SPEED LIMIT OF 45 MPH OR LESS; OR TEST LEVEL III FOR WORK ZONES WITH POSTED SPEED LIMIT OF 50 MPH OR GREATER. TMA MAY EITHER BE TRUCK MOUNTED OR TRAILER MOUNTED.
- 3- SEE THE DEPARTMENT'S APPROVED PRODUCT LIST AT <https://apps.dot.state.nc.us/vendor/approvedproducts>.

SHEET 1 OF 1
1165.01

Typical Sections for Litter Pickup Operation

TYPICAL INTERCHANGE CONFIGURATIONS

SHOWING THE LIMITS FOR

LITTER/DEBRIS REMOVAL.

- Litter removal includes all areas visible from the road



Litter Pickup Operation Diagrams

Diagram 1

GENERAL NOTES

(1) THE FOLLOWING OPTIONS MAY BE USED AS THE FIRST ADVANCE WARNING ATTACHED TO THE VEHICLE AS HIGH AS POSSIBLE AND IN A MANNER THAT IS VISIBLE TO TRUCK DRIVERS APPROXIMATELY 1 MILE IN LENGTH.

A. TRUCK MOUNTED ADVANCE WARNING SIGNS
 B. TRUCK MOUNTED CHANGEABLE MESSAGE SIGN (CMS)
 C. STATIONARY CHANGEABLE MESSAGE SIGN (CMS) (USE NEXT 5 MILES AND MAKE CIRCLE TO PICK UP SIGNS)

(2) TOTAL DISTANCE BETWEEN FIRST AND LAST VEHICLE IN CARAVAN SHOULD BE APPROXIMATELY ONE (1) MILE IN LENGTH.

(3) IF USING STATIONARY CMS, THE TOTAL DISTANCE BETWEEN THE CMS AND APPLICATION VEHICLE SHOULD NOT EXCEED 5 MILES AND SIGN SHOULD READ "MACHINERY IN ROAD NEXT 5 MILES".

(4) SIGNS ON VEHICLES SHOULD BE MOUNTED A MINIMUM OF ONE (1) FOOT FROM THE GROUND AND SHOULD NOT BLOCK THE MOTORIST'S SIGHT OF THE FLASHING ARROW BOARD AND/OR WARNING LIGHTS.

(5) SIGN W20-5L SHOULD BE PLACED ON BACK OF PROTECTION VEHICLE AND SIGN W20-5LD ON BACK OF ADVANCE WARNING VEHICLE IN MULTILANE DIVIDED ROADWAYS SO VEHICLES APPROACHING FROM REAR ARE NOTIFIED OF OPERATION.

(6) RADIO COMMUNICATION BETWEEN VEHICLES IS RECOMMENDED.

(7) USE WARNING LIGHTS WITH ATLEAST 50% BEING AMBER IN COLOR ATTACHED TO THE VEHICLE AS HIGH AS POSSIBLE AND IN A MANNER THAT IS VISIBLE TO TRUCK DRIVERS APPROXIMATELY 1 MILE IN LENGTH. THIS REQUIREMENT DOES NOT APPLY TO DUMP TRUCKS, BUT IS ENCOURAGED.

(8) USE OF TRUCK MOUNTED CMS'S ARE OPTIONAL WITH ADVANCED WARNING VEHICLES.

(9) USE A TYPE "C" FLASHING ARROW BOARD.
 PANEL TYPE MIN. SIZE 96" X 48"

(10) MAY USE A TYPE "B" FLASHING ARROW BOARD ON 1ST ADVANCE WARNING VEHICLE.
 PANEL TYPE MIN. SIZE 60" X 30"

(11) IF 43" X 73" CMS IS USED, LETTER HEIGHT MUST BE 18".

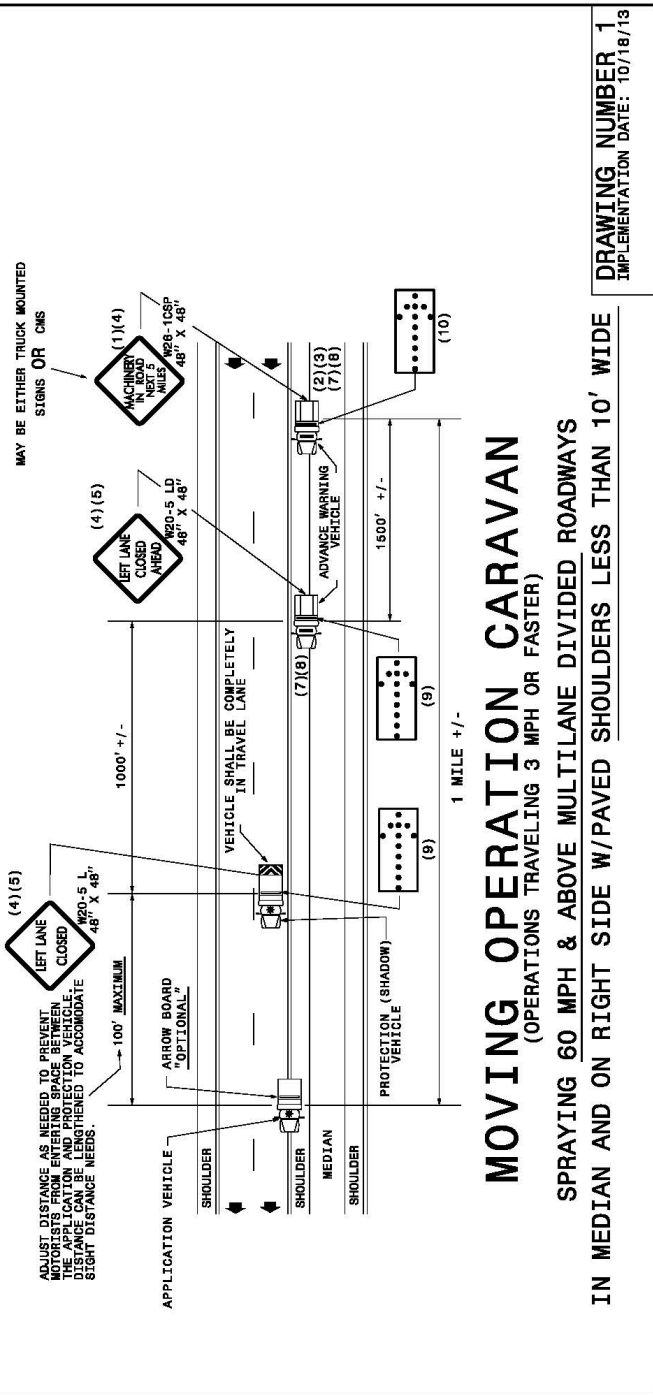
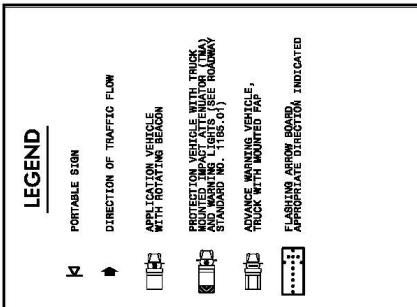

MOVING OPERATION CARAVAN
 (OPERATIONS TRAVELING 3 MPH OR FASTER)
 SPRAYING 60 MPH & ABOVE MULTILANE DIVIDED ROADWAYS
 IN MEDIAN AND ON RIGHT SIDE W/PAVED SHOULDERS LESS THAN 10' WIDE

DRAWING NUMBER 1
 IMPLEMENTATION DATE: 10/18/13

Diagram 2

- GENERAL NOTES**
- (1) THE FOLLOWING OPTIONS MAY BE USED FOR THE FIRST ADVANCE WARNING THE MOTORISTS SEES:
 - A. TRUCK MOUNTED ADVANCE WARNING SIGNS
 - B. TRUCK MOUNTED CHANGEABLE MESSAGE SIGN (CMS)
 - C. STATIONARY CHANGEABLE MESSAGE SIGN (CMS) (MUST USE 'NEXT 5 MILES' AND MAKE CIRCLE TO PICK UP CMS)
 - (2) TOTAL DISTANCE BETWEEN FIRST AND LAST VEHICLE IN CARAVAN SHOULD BE APPROXIMATELY ONE (1) MILE IN LENGTH.
 - (3) IF USING STATIONARY CMS, THE TOTAL DISTANCE BETWEEN THE CMS AND APPLICATION VEHICLE SHOULD NOT EXCEED 5 MILES AND SIGN SHOULD READ "SHOULDER CLOSED".
 - (4) SIGNS ON VEHICLES SHOULD BE MOUNTED A MINIMUM OF ONE (1) FOOT FROM THE GROUND AND SHOULD NOT BLOCK THE MOTORIST'S SIGHT OF THE FLASHING ARROW BOARD AND/OR WARNING LIGHTS.
 - (5) SIGN W21-6BSP SHOULD BE PLACED ON BACK OF ADVANCE WARNING VEHICLE IN MULTILANE DIVIDED TRAFFIC SO VEHICLES APPROACHING FROM REAR ARE NOTIFIED OF OPERATION.
 - (6) RADIO COMMUNICATION BETWEEN VEHICLES IS RECOMMENDED.
 - (7) USE WARNING LIGHTS WITH ATLEAST 50% BEING AMBER IN COLOR ATTACHED TO THE VEHICLE AS HIGH AS POSSIBLE AND IN A MANNER SUCH THAT THEY ARE NOT OBSCURED BY EQUIPMENT OR SUPPLIES. VEHICLE HAZARD SIGNALS OR LIGHTS MAY BE USED TO SUPPLEMENT EACH OTHER. FLASHING ARROW BOARD AND/OR FLASHING ARROW SIGNS AND EQUIPMENT NOT INSIDE LANE CLOSURE OR BEHIND A BARRIER. THIS REQUIREMENT DOES NOT APPLY TO DUMP TRUCKS, BUT IS ENCOURAGED.
 - (8) USE OF CMS'S ARE OPTIONAL WITH ADVANCED WARNING VEHICLES.
 - (9) USE A TYPE "C" FLASHING ARROW BOARD.
MIN. SIZE 96"X48"
 - (10) IF 43" X 73" CMS IS USED, LETTER HEIGHT MUST BE 18".

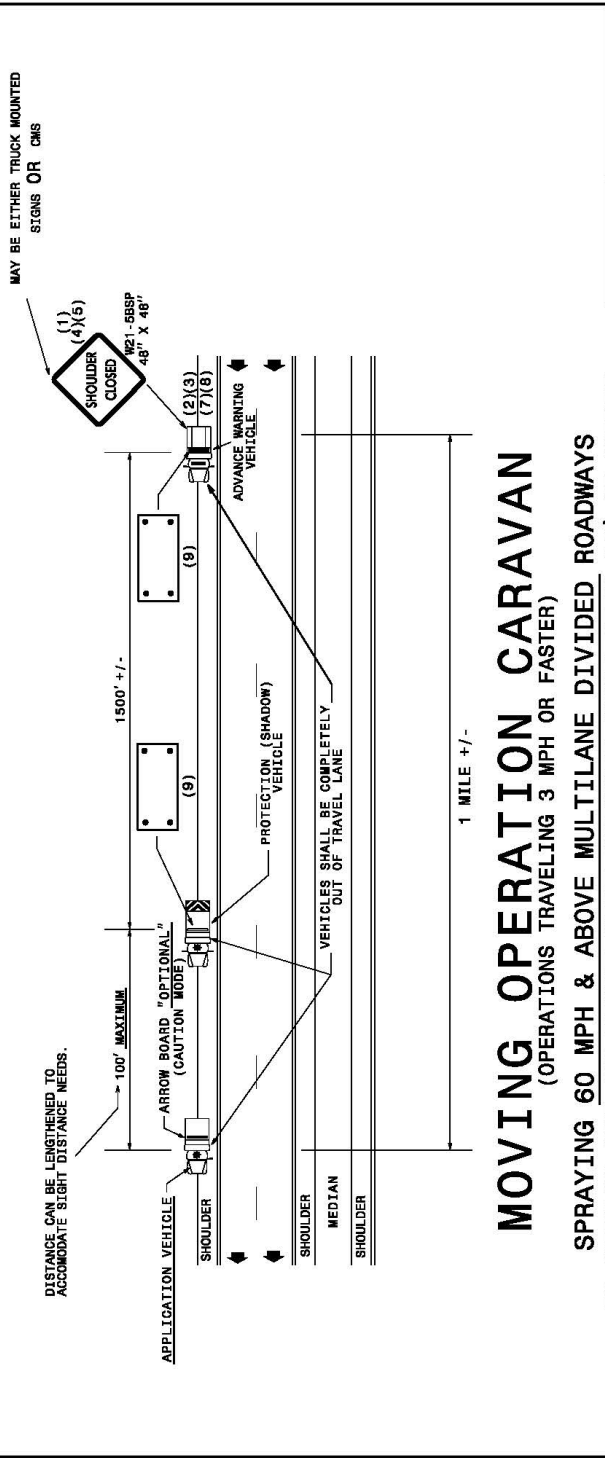
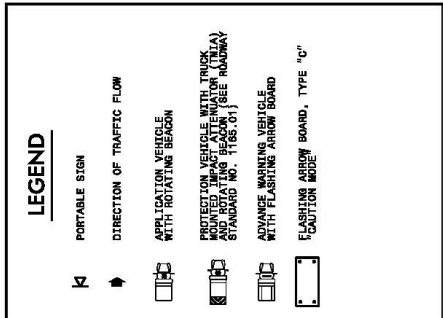

Diagram 3

GENERAL NOTES

(1) THE FOLLOWING OPTIONS MAY BE USED AS THE FIRST ADVANCE WARNING THE MOTORISTS SEES:
 A. TRUCK MOUNTED ADVANCE WARNING SIGNS
 B. MOVING CHANGEABLE MESSAGE SIGN (CMS)

(2) TOTAL DISTANCE BETWEEN FIRST AND LAST VEHICLE IN CARAVAN SHOULD BE APPROXIMATELY ONE (1) MILE IN LENGTH.

(3) SIGNS ON VEHICLES SHOULD BE MOUNTED A MINIMUM OF ONE (1) FOOT FROM THE GROUND AND SHOULD NOT BLOCK THE MOTORIST'S SIGHT OF THE FLASHING ARROW BOARD AND/OR WARNING LIGHTS.

(4) SIGN W20-5L SHOULD BE PLACED ON BACK OF PROTECTION VEHICLE AND DIVERTED TRAFFIC TO OTHER MULTILANE DIVIDED ROADWAYS. MULTILANE NOTIFIED OF OPERATION.

(5) RADIO COMMUNICATION BETWEEN VEHICLES IS RECOMMENDED.

(6) USE WARNING LIGHTS WITH ATLEAST 50% BEING AMBER IN COLOR ATTACHED TO THE VEHICLE AS HIGH AS POSSIBLE AND IN A MANNER SUCH THAT THEY ARE NOT OBSCURED BY EQUIPMENT OR SUPPLIES. VEHICLE HAZARD SIGNALS OR LIGHTS MAY BE USED TO SUPPLEMENT THIS REQUIREMENT. THIS REQUIREMENT DOES NOT APPLY TO WORK VEHICLES AND EQUIPMENT. THIS REQUIREMENT DOES NOT APPLY TO DUMP TRUCKS, BUT IS ENCOURAGED.

(7) USE OF CMS'S ARE OPTIONAL WITH ADVANCED WARNING VEHICLES.

(8) USE A TYPE "C" FLASHING ARROW BOARD.
 PANEL TYPE 96"X48"
 C

(9) USE A TYPE "B" FLASHING ARROW BOARD.
 PANEL TYPE 60"X30"
 B

(10) IF 49" X 73" CMS IS USED, LETTER HEIGHT MUST BE 18".

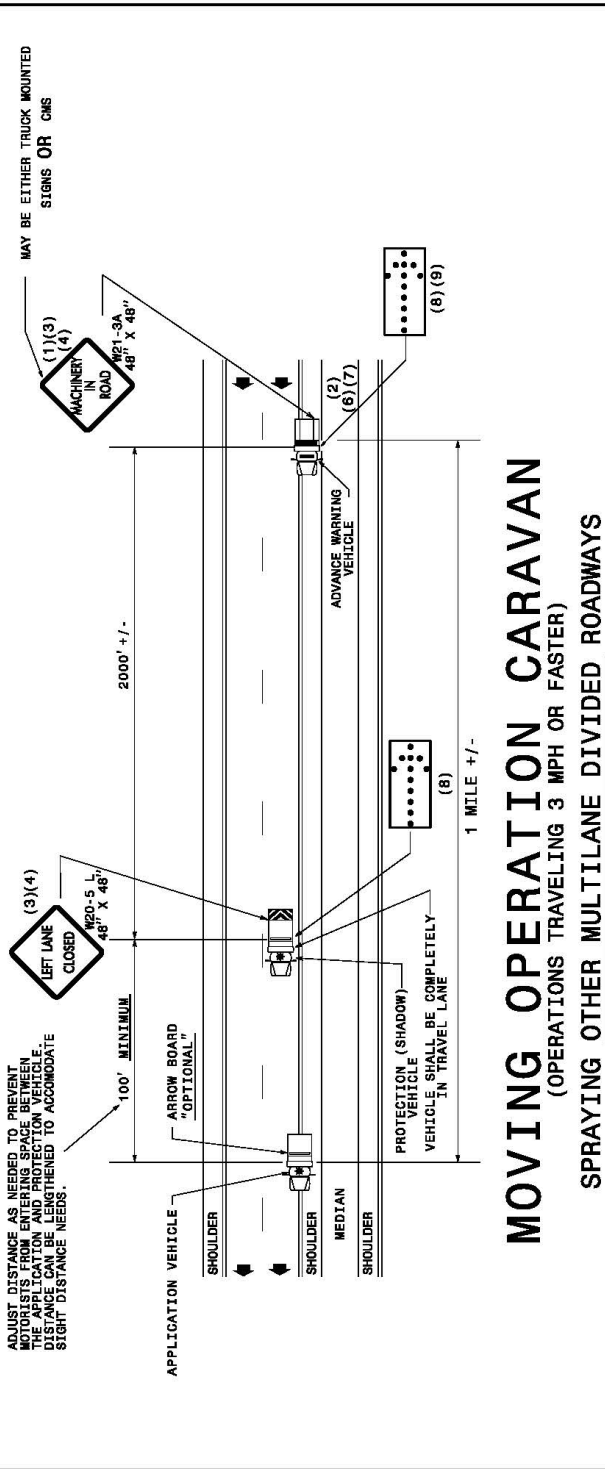
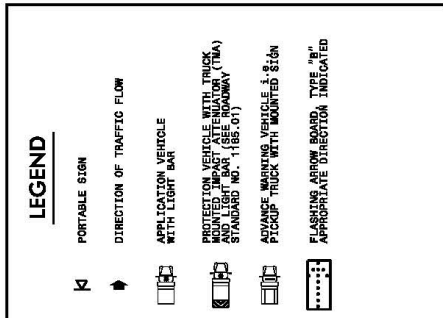

MOVING OPERATION CARAVAN
 (OPERATIONS TRAVELING 3 MPH OR FASTER)
 SPRAYING OTHER MULTILANE DIVIDED ROADWAYS
 IN MEDIAN AND ON RIGHT SIDE W/PAVED SHOULDERS LESS THAN 10' WIDE

DRAWING NUMBER 3
 IMPLEMENTATION DATE: 10/18/13

Diagram 4

GENERAL NOTES

(1) THE FOLLOWING OPTIONS MAY BE USED AS THE FIRST ADVANCE WARNING THE MOTORISTS SEE:

- A. TRUCK MOUNTED ADVANCE WARNING SIGNS
- B. MOVING CHANGEABLE MESSAGE SIGN (CMS)
- C. GROUND MOUNTED ADVANCE WARNING SIGNS (MUST USE "NEXT 5 MILES" AND MAKE CIRCLE TO INDICATE MESSAGE LENGTH)
- D. STATIONARY CHANGEABLE MESSAGE SIGN (CMS) (MUST USE "NEXT 5 MILES" AND MAKE CIRCLE TO PICK UP CMS)

(2) TOTAL DISTANCE BETWEEN FIRST AND LAST VEHICLE IN CARAVAN SHOULD BE APPROXIMATELY ONE (1) MILE IN LENGTH.

(3) IF USING GROUND MOUNTED ADVANCE WARNING SIGNS OR STATIONARY OR CMS, THE TOTAL DISTANCE BETWEEN THE FIRST ADVANCE WARNING SIGN AND APPLICATION VEHICLE SHOULD NOT EXCEED 5 MILES, AND SIGN W26-1CSP SHOULD READ "MACHINERY IN ROAD NEXT 5 MILES".

(4) SIGNS ON VEHICLES SHOULD BE MOUNTED A MINIMUM OF ONE (1) FOOT FROM THE GROUND AND SHOULD NOT BLOCK THE MOTORIST'S SIGHT OF THE FLASHING ARROW BOARD AND/OR LIGHT BAR.

(5) SIGN W26-1BSP OR R4-7A SHOULD BE PLACED ON FRONT OF THE APPLICATION VEHICLE AND SIGN W26-1BSP OR W21-3A ON BACK OF THE PROTECTION VEHICLE IN TWO-LANE, TWO-WAY TRAFFIC SO VEHICLE APPROACHING FROM THE FRONT AND REAR ARE NOTIFIED OF OPERATION.

LEGEND

- PORTABLE SIGN
- DIRECTION OF TRAFFIC FLOW
- APPLICATION VEHICLE WITH ROTATING BEAM
- PROTECTION VEHICLE WITH TRUCK MOUNTED IMPACT ATTENUATION (TMA) STANDARD NO. 118-01
- ADVANCE WARNING VEHICLE 3-6 SIGN
- FLASHER ARROW BOARD, TYPE "B"
- CAUTION ARROW BOARD

GENERAL NOTES

(6) IF A LEAD VEHICLE IS ADDED TO OPERATION, IT SHOULD HAVE THE SAME ADVANCE WARNING SIGNS AS THE APPLICATION VEHICLE SHOWN BELOW.

(7) RADIO COMMUNICATION BETWEEN VEHICLES IS RECOMMENDED.

(8) USE WARNING LIGHTS WITH AT LEAST 50% BEING AMBER IN COLOR ATTACHED TO THE VEHICLE AS HIGH AS POSSIBLE AND IN A MANNER SUCH THAT THEY ARE NOT OBSCURED BY EQUIPMENT OR SUPPLIES. VEHICLE HAZARD SIGNALS OR LIGHTS MAY BE USED TO SUPPLEMENT THIS REQUIREMENT. THIS REQUIREMENT APPLIES TO ALL WORK VEHICLES OPERATING IN A CONSTRUCTION AREA TO DUMP TRUCKS, BUT IS ENCOURAGED.

(9) USE OF CMS'S ARE OPTIONAL WITH ADVANCED WARNING VEHICLES.

(10) USE A TYPE "B" FLASHING ARROW BOARD.
 PANEL TYPE MIN. SIZE
 B 60" X 30"

(11) IF 43" X 73" CMS IS USED, LETTER HEIGHT MUST BE 18".

MAY BE EITHER TRUCK MOUNTED SIGNS OR CMS

ADJUST DISTANCE AS NEEDED TO PREVENT CUTTING OFF THE SIGHT OF THE APPLICATION AND PROTECTION VEHICLE. DISTANCE CAN BE LENGTHENED TO ACCOMMODATE SIGHT DISTANCE NEEDS.

VEHICLE SHALL BE COMPLETELY IN TRAVEL LANE

1 MILE +/-

MOVING OPERATION CARAVAN
 (OPERATIONS TRAVELING 3 MPH OR FASTER)
 SPRAYING TWO-LANE TWO-WAY ROADWAYS
 WITH ADT GREATER THAN 5000

DRAWING NUMBER 4
 IMPLEMENTATION DATE: 10/18/13

Diagram 5

GENERAL NOTES

(1) THE FOLLOWING OPTIONS MAY BE USED AS THE FIRST ADVANCE WARNING THE MOTORISTS SEE:

- A. TRUCK MOUNTED ADVANCE WARNING SIGNS
- B. MOVING CHANGEABLE MESSAGE SIGN (CMS)
- C. GROUND MOUNTED ADVANCE WARNING SIGNS (W28-1CSP) (MUST USE 'NEXT 5 MILES' AND MAKE CIRCLE TO PICK UP SIGNS)
- D. GROUND MOUNTED CHANGEABLE MESSAGE SIGN (CMS) (MUST USE 'NEXT 5 MILES' AND MAKE CIRCLE TO PICK UP CMS)

(2) TOTAL DISTANCE BETWEEN FIRST AND LAST VEHICLE IN CARAVAN SHOULD BE APPROXIMATELY ONE (1) MILE IN LENGTH.

(3) IF USING GROUND MOUNTED ADVANCE WARNING SIGNS OR STATIONARY CMS, THE TOTAL DISTANCE BETWEEN THE FIRST ADVANCE WARNING SIGN OR CMS AND APPLICATION VEHICLE SHOULD NOT EXCEED 5 MILES AND SIGN W21-3BSP SHOULD READ 'MACHINERY IN ROAD NEXT 5 MILES'.

(4) SIGNS ON VEHICLES SHOULD BE MOUNTED A MINIMUM OF ONE (1) FOOT FROM THE GROUND AND SHOULD NOT BLOCK THE MOTORIST'S SIGHT OF THE FLASHING ARROW BOARD AND/OR WARNING LIGHTS.

(5) SIGN W26-1BSP OR R4-7A SHOULD BE PLACED ON FRONT OF THE APPLICATION VEHICLE AND SIGN W26-1BSP OR W21-3A ON BACK OF THE PROTECTION VEHICLE IN TWO-LANE, TWO-WAY TRAFFIC SO VEHICLE APPROACHING FROM THE FRONT AND REAR ARE NOTIFIED OF OPERATION.

LEGEND

PORTABLE SIGN

DIRECTION OF TRAFFIC FLOW

APPLICATION VEHICLE WITH ROTATING BEACON

ADVANCE WARNING VEHICLE i.e. PICKUP TRUCK WITH MOUNTED SIGN

FLASHING ARROW BOARD, TYPE "B"

CAUTION MODE

(6) IF A LEAD VEHICLE IS ADDED TO OPERATION IT SHOULD HAVE THE SAME ADVANCE WARNING SIGNS AS THE APPLICATION VEHICLE SHOWN BELOW.

(7) RADIO COMMUNICATION BETWEEN VEHICLES IS RECOMMENDED.

(8) USE WARNING LIGHTS WITH ATLEAST 50% BEING AMBER IN COLOR ATTACHED TO THE VEHICLE AS HIGH AS POSSIBLE AND IN A MANNER SUCH THAT THEY ARE NOT OBSCURED BY EQUIPMENT OR SUPPLIES. SIGN ON THE TRUCK MUST BE MOUNTED AT LEAST 4 FEET ABOVE THE VEHICLE AND THIS REQUIREMENT APPLIES TO ALL WORK VEHICLES AND EQUIPMENT NOT INSIDE A LANE CLOSURE OR BEHIND A BARRIER. THIS REQUIREMENT DOES NOT APPLY TO DUMP TRUCKS, BUT IS ENCOURAGED.

(9) USE OF CMS'S ARE OPTIONAL WITH ADVANCED WARNING VEHICLES.

(10) USE A TYPE "B" FLASHING ARROW BOARD.
 PANEL TYPE MIN. SIZE 60"x30"
 B

(11) IF 43" X 73" CMS IS USED, LETTER HEIGHT MUST BE 18".

MOVING OPERATION CARAVAN
 (OPERATIONS TRAVELING 3 MPH OR FASTER)
 SPRAYING TWO-LANE TWO-WAY ROADWAYS
 WITH ADT LESS THAN OR EQUAL TO 5000

DRAWING NUMBER 5
 IMPLEMENTATION DATE: 10/18/13

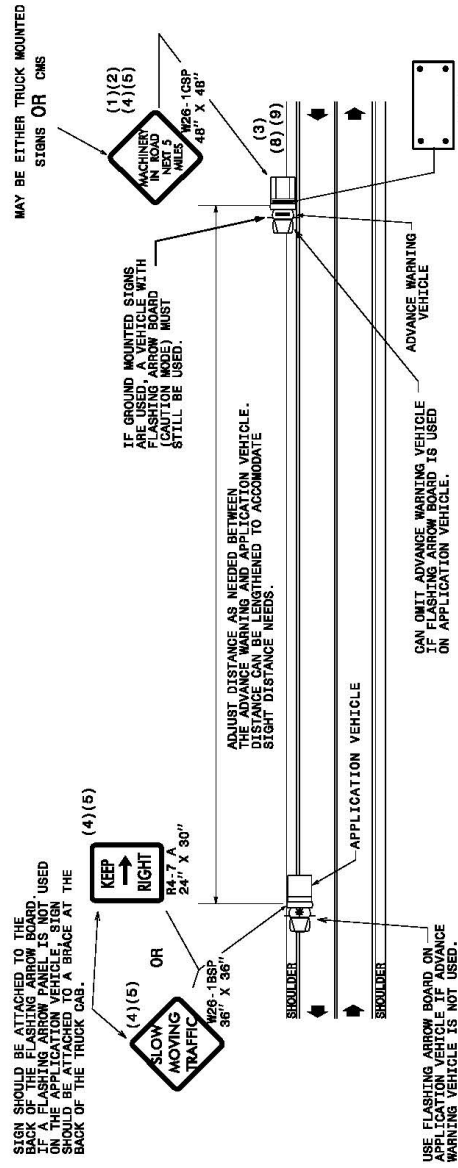

Multi-lane Operation Diagrams

Diagram 1

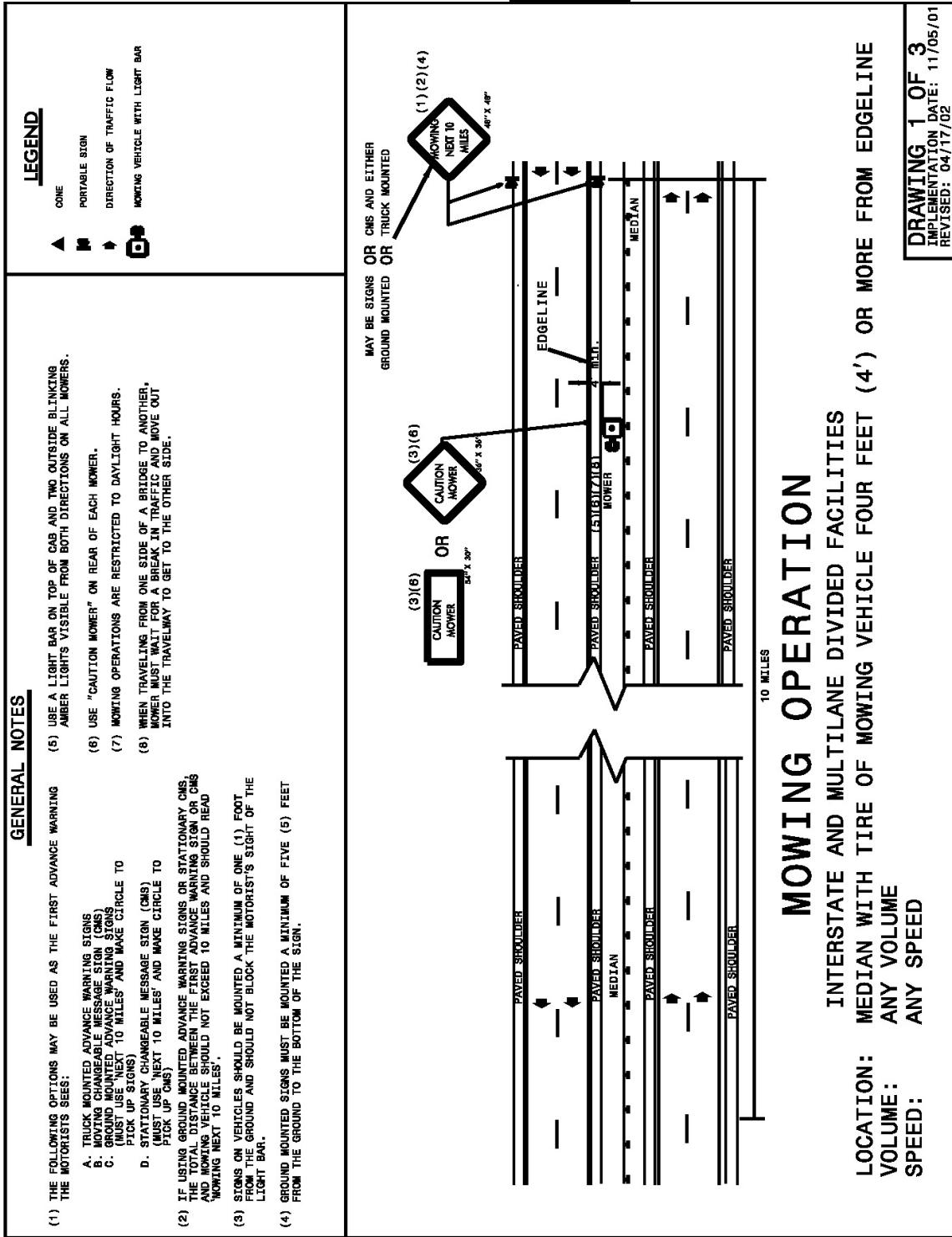

Diagram 2

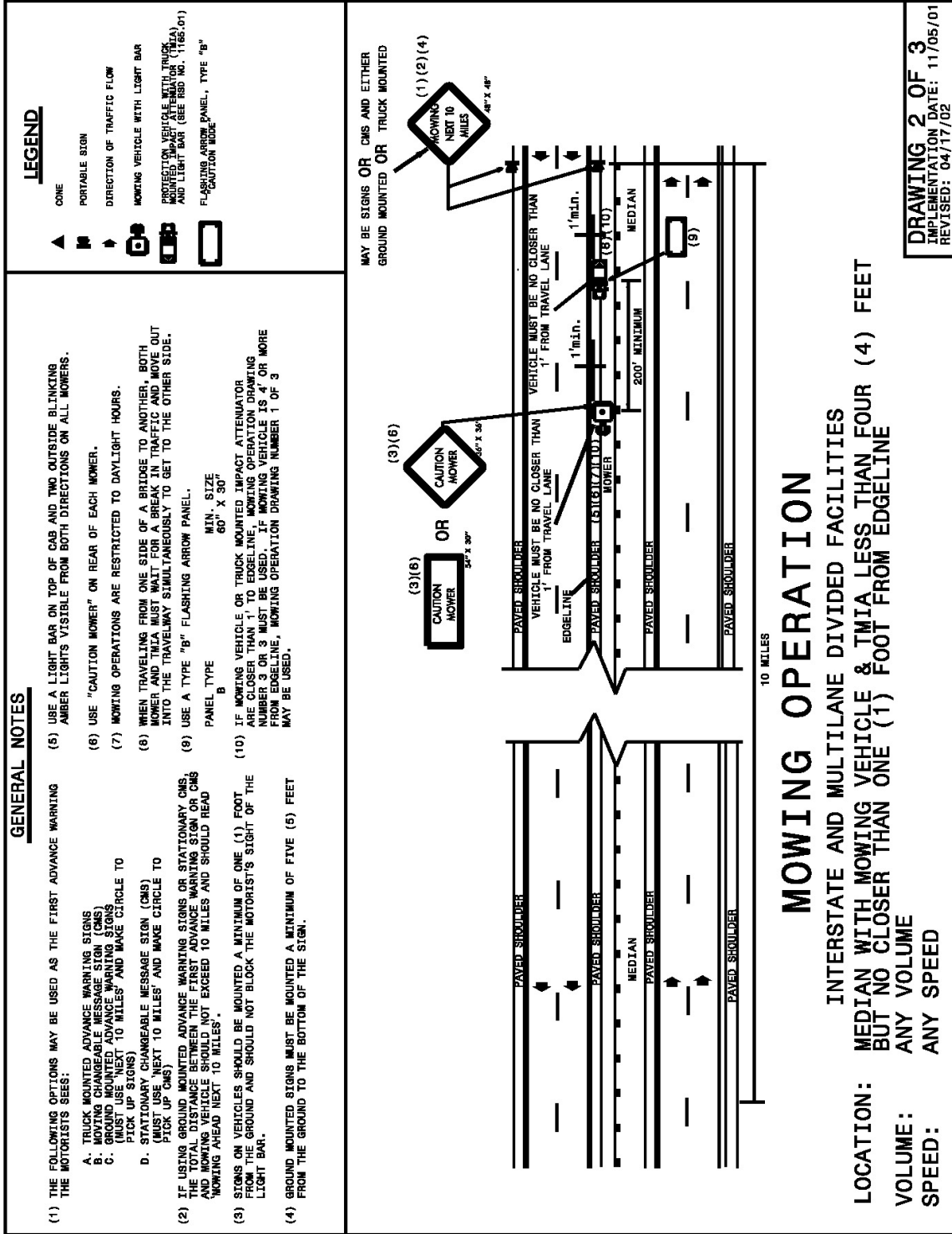
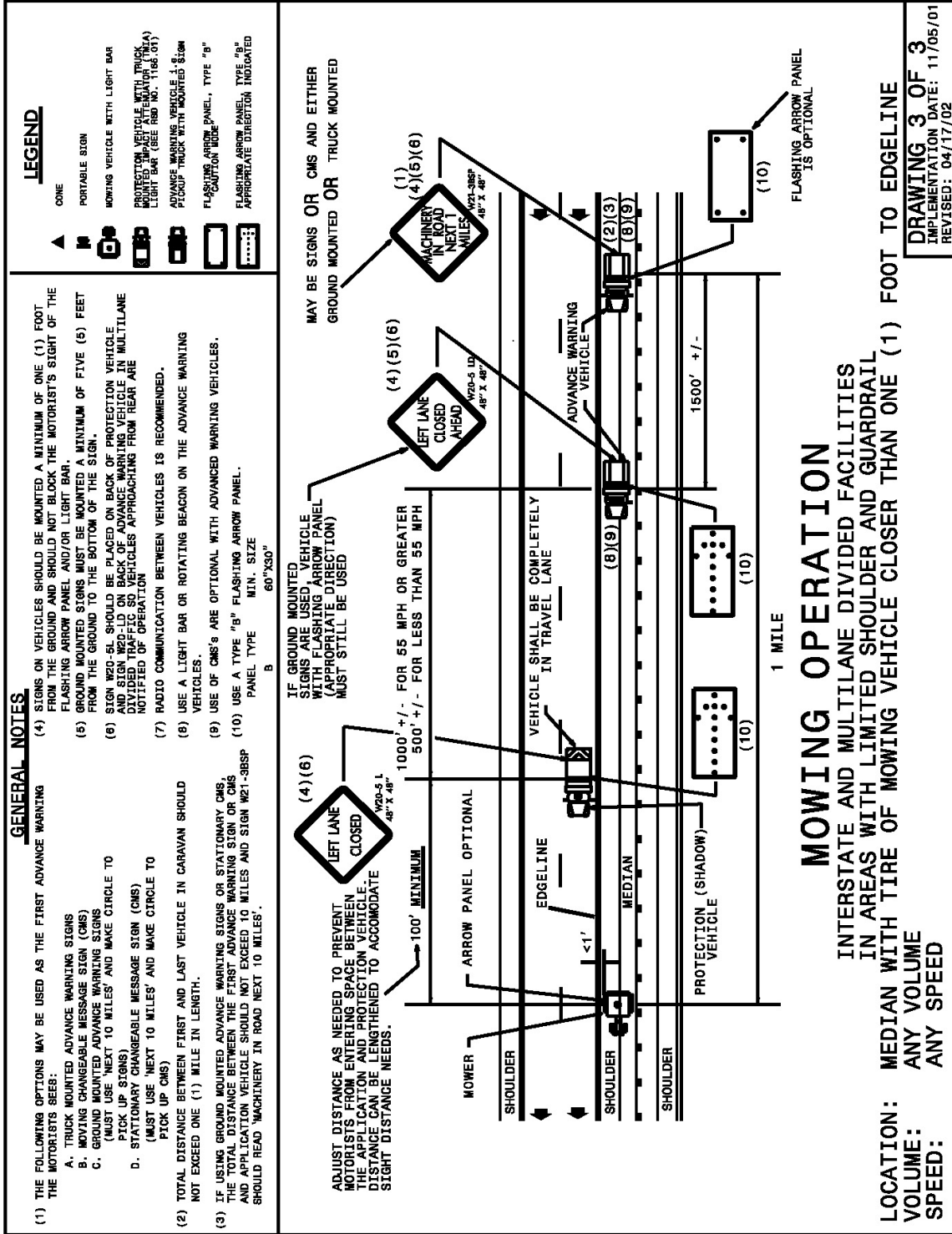

Diagram 3



PREPARATION AND SUBMISSION OF TRADITIONAL PAPER BIDS

As stated under “AWARD OF CONTRACT” above, the Engineer will evaluate the Bidder's proposal to determine the responsibility of the bid and insure compliance with contract. The Engineer, using his/her discretion, will determine whether a bidder is “responsible” and capable of performing the required work. The Bidder should demonstrate an understanding of the requirements of the contract, and that the requirements have been addressed in his/her bid to the satisfaction of the Engineer. The Bidder should demonstrate that he/she is capable of performing the required work under this contract, to the satisfaction of the Engineer.

PLEASE READ ALL INSTRUCTIONS CAREFULLY BEFORE PREPARING AND SUBMITTING YOUR BID.

Paper bids shall be prepared and submitted in accordance with SSRS § 102-8 and the following requirements. Failure to comply with any requirement may cause the bid to be irregular and may be grounds for rejection of the bid. Only the Bid Submittal Package pages and all signed addenda shall be submitted as your proposal. **One (1) signed original and one (1) signed copy of the Bid Submittal Package and all signed addenda; shall be submitted as the Bidder’s proposal.**

1. The attached Bid Submittal Package (Bid Submittal Pages 1 of 15 through 15 of 15) furnished by the Department shall be used. The bid shall be submitted on the same proposal that has been furnished to the bidder by the Department. Copies of previous proposals shall be rejected. The Bidder shall provide the information requested on Bid Submittal Page 3 of 15 (use additional pages and/or attachments if needed).
2. All entries on the Contract Bid Form, including signatures shall be written in ink or typed.
3. The Bidder shall submit a unit price for each item listed in the Contract Bid Form. The Unit Price for the various contract items shall be written in figures. **Unit Prices shall be rounded off by the Bidder to contain no more than TWO (2) decimal places.**
4. An Amount Bid shall be entered in the Contract Bid Form for each item that a Unit Price has been entered. The Amount Bid for each item shall be determined by multiplying each Unit Price by the quantity for that item, and shall be written in figures in the Amount Bid column in the Contract Bid Sheet.
5. The total bid shall be written in figures in the Total Bid for Project section in the Contract Bid Form. The Total Bid for Project shall be determined by adding the Amount Bid for each item.
6. Changes to any entry shall be made by marking through the entry in ink and making the correct entry adjacent thereto in ink. A representative of the Bidder shall initial the change in ink. Do not use correction fluid, correction tape or similar product to make corrections.
7. The bid shall be properly executed on the included **Execution of Bid – Non-collusion Affidavit, Debarment Certification and Gift Ban Certification** form. All bids are to include the following information:
 - a. Name of corporation, partnership, limited liability company, joint venture, individual or firm, submitting bid.
Corporations that have a corporate seal should include it on the bid.
 - b. Name of individual or representative submitting bid and position or title held on behalf of the bidder.
 - c. Name, signature, and position or title of witness.
8. The bid shall not contain any unauthorized additions, deletions, or conditional bids.
9. The Bidder shall not add any provision reserving the right to accept or reject an award, or to enter into a contract pursuant to an award.

10. The Bid Submittal Package shall be placed in a sealed envelope and shall be delivered to and received in the DOT Purchasing Section by **2:00 pm on March 12, 2025** at the address indicated in the table below:

MAILING ADDRESS FOR DELIVER OF BID VIA U.S. POSTAL SERVICE	OFFICE ADDRESS FOR DELIVERY BY ANY OTHER MEANS, SPECIAL DELIVERY, HAND DELIVERY, OVERNIGHT DELIVERY OR BY ANY OTHER CARRIER
BID NUMBER: 54-SH-05-PR18939 Attn: Steve Hussey North Carolina Department of Transportation Purchasing Section Address: 1510 Mail Service Center Raleigh, NC 27699-1510	BID NUMBER: 54-SH-05-PR18939 Attn: Steve Hussey North Carolina Department of Transportation Purchasing Section Address: 1 South Wilmington Street, Room 334B Raleigh, NC 27601

IMPORTANT NOTE: All paper bids shall be physically delivered to the office address listed above on or before the bid deadline in order to be considered timely, regardless of method of delivery (including U.S. mail). **This is an absolute requirement.** All risk of late arrival due to unanticipated delay – whether delivered by hand, U.S. Postal Service, courier or other delivery service is entirely on the Vendor. It is the sole responsibility of the Vendor to have the bid physically in this Office by the specified time and date of opening. The time of delivery will be marked on each bid when received, and any bid received after the bid submission deadline will be rejected. Sealed bids, subject to the conditions made a part hereof, will be received at the address indicated in the table in this Section, for furnishing and delivering the commodity or service as described herein.

Note that the U.S. Postal Service does not deliver mail to the specified office address but to the State’s Mail Service Center. Vendors are cautioned that bids sent via U.S. Mail, including Express Mail, may not be delivered by the Mail Service Center to the agency’s purchasing office on the due date in time to meet the bid deadline. All Vendors are urged to take the possibility of delay into account when submitting a bid.

All bids shall be submitted in a sealed envelope. Clearly mark each package with: (1) Vendor name; (2) the IFB number; and (3) the due date. Address the package(s) for delivery as shown in the table above.

Bids shall be marked on the outside of the sealed envelope with the Vendor’s name, IFB number, and date and time of opening. If Vendor is submitting more than one bid, each bid shall be submitted in a separate sealed envelope and marked accordingly. For delivery purposes, separate sealed bids from a single Vendor may be included in the same outer package. Do not include bids for more than one solicitation in the same package.

Failure to address proposals correctly could result in delayed delivery service.

OPENING OF BIDS

Bids subject to the conditions made a part hereof will be received until 2:00 pm on March 12, 2025 and then publicly opened for furnishing the services as described herein.

Opening of bids is to be in the NCDOT Transportation Building Complex located at 1 South Wilmington Street, Raleigh 27601.

NOTE: Parking at the Transportation Building Complex is limited. Arrive early!

BID SUBMITTAL PACKAGE

Litter/Debris Removal and Recycling, Upon Request
NCDOT Highway Division 5
Wake and Franklin Counties

DATE

February 19, 2025

PROPOSAL

54-SH-05-PR18939

CONTRACTING AGENCY

State of North Carolina
Department of Transportation
Raleigh, North Carolina

Bidder: _____
Company Name

**NORTH CAROLINA DEPARTMENT OF TRANSPORTATION
CONTRACT BID FORM**

BID PROPOSAL NO.: 54-SH-05-PR18939

WBS ELEMENT NOS.: VARIOUS

COUNTIES: WAKE AND FRANKLIN – DIVISION 5

TYPE OF WORK: LITTER/DEBRIS REMOVAL AND RECYCLING, UPON REQUEST, ON INTERSTATE, PRIMARY AND SECONDARY ROADS

LINE NO.	SEC NO.	ITEM DESCRIPTION	EST. QUANT.	UNIT	UNIT PRICE	AMOUNT BID
1	SP	Litter/Debris Removal and Recycling on Interstate Highways	250	SHM	\$	\$
2	SP	Litter/Debris Removal and Recycling on Primary Divided Highways	250	SHM	\$	\$
3	SP	Litter/Debris Removal and Recycling on Primary Undivided Highways	350	SHM	\$	\$
4	SP	Litter/Debris Removal and Recycling on Secondary Divided Highways	100	SHM	\$	\$
5	SP	Litter/Debris Removal and Recycling on Secondary Undivided Highways	1,200	SHM	\$	\$
6	SP	Isolated Dump Sites	25	EA	\$	\$
7	SP	Isolated Bulk Items	100	EA	\$	\$

TOTAL BID FOR PROJECT: \$ _____
--

THIS SECTION TO BE COMPLETED BY NORTH CAROLINA DEPARTMENT OF TRANSPORTATION

This bid has been reviewed in accordance with Article 103-1 of the Standard Specifications for Roads and Structures 2024.

Reviewed by _____ (date)

Accepted by NCDOT _____ (date)
Division Engineer

CONTRACTOR INFORMATION

Company Name _____

Contractor License Number: _____

Address: _____

Phone: _____

Email Address: _____

Name of individual authorized to answer questions concerning the information contained herein:

Name: _____

Telephone Number(s): _____

Email Address: _____

FEDERAL EMPLOYER IDENTIFICATION NUMBER

The Federal Employer Identification Number or alternate identification number (e.g., Social Security Number) is used for internal processing, including bid tabulation.

Pursuant to N.C.G.S. § 132-1.10(b) this identification number shall not be released to the public. This page is segregated for ease of redaction pursuant to a valid public records request.

Identification Number

This page will be removed and shredded, or otherwise kept confidential, before the procurement file is made available for public inspection.

LIST OF MB & WB SUBCONTRACTORS

Firm Name and Address	Circle One	Item No.	Item Description	* Agreed upon Unit Price	** Dollar Volume of Item
Name Address	MBE WBE				
Name Address	MBE WBE				
Name Address	MBE WBE				
Name Address	MBE WBE				
Name Address	MBE WBE				
Name Address	MBE WBE				

* The Dollar Volume shown in this column shall be the Actual Price Agreed Upon by the Prime Contractor and the MBE/WBE subcontractor, and these prices will be used to determine the percentage of the MBE/WBE participation in the contract.

** Dollar Volume of MBE/WBE Subcontractor Percentage of Total Contract Bid Price:

**** Dollar Volume of MBE Subcontractor** \$ _____

MBE Percentage of Total Contract Bid Price _____ %

**** Dollar Volume of WBE Subcontractor** \$ _____

WBE Percentage of Total Contract Bid Price _____ %

If firm is a Material Supplier Only, show Dollar Volume as 60% of Agreed Upon Amount from Letter of Intent.

If firm is a Manufacturer, show Dollar Volume as 100% of Agreed Upon Amount from Letter of Intent.

CONTRACTOR'S WORK EXPERIENCE AND REFERENCES

Bidders shall supply a minimum of three (3) references covering work experience on a contract basis, related to litter/debris removal and recycling services. These references are to include private commercial firms, governmental agencies (federal, state, county, city, etc.), and any other references related to litter/debris removal and recycling services which this business or its supervisors, managers, owners or other persons with supervisory responsibility for performance of this contract have had within the last three (3) years, or longer if necessary to attain the required number of references. The references are one factor that will be used by the Engineer to determine whether a bidder is "responsible" and capable or able to perform the work necessary under the contract. ALL REFERENCE CONTACT INFORMATION SHOULD BE CURRENT.

- 1. Agency or Firm Name: _____
Physical Address: _____
Mailing Address: _____
Contact Person: _____ Telephone(s): _____
Email address: _____
Length of Contract: _____ Dates of Contract: _____

- 1. Agency or Firm Name: _____
Physical Address: _____
Mailing Address: _____
Contact Person: _____ Telephone(s): _____
Email address: _____
Length of Contract: _____ Dates of Contract: _____

- 3. Agency or Firm Name: _____
Physical Address: _____
Mailing Address: _____
Contact Person: _____ Telephone(s): _____
Email address: _____
Length of Contract: _____ Dates of Contract: _____

EXECUTION OF BID

NON-COLLUSION, DEBARMENT AND GIFT BAN CERTIFICATION

CORPORATION

The bidder being duly sworn, solemnly swears (or affirms) that neither he, nor any official, agent or employee has entered into any agreement, participated in any collusion, or otherwise taken any action which is in restraint of free competitive bidding in connection with any bid or contract, that the bidder has not been convicted of violating *N.C.G.S. §133-24* within the last three years, and that the bidder intends to do the work with his own bona fide employees or subcontractors and will not bid for the benefit of another contractor.

By submitting this non-collusion, debarment and gift ban certification, the Contractor is attesting his status under penalty of perjury under the laws of the United States in accordance with the Debarment Certification attached, provided that the Debarment Certification also includes any required statements concerning exceptions that are applicable.

N.C.G.S. §133-32 and Executive Order 24 prohibit the offer to, or acceptance by, any State Employee of any gift from anyone with a contract with the State, or from any person seeking to do business with the State. By execution of any response in this procurement, you attest, for your entire organization and its employees or agents, that you are not aware that any such gift has been offered, accepted, or promised by any employees of your organization.

SIGNATURE OF PREQUALIFIED BIDDER

_____ Full name of Corporation

_____ Address as Prequalified

Attest _____ By _____
Secretary/Assistant Secretary President/Vice President/Assistant Vice President
(Select appropriate title) (Select appropriate title)

_____ Print or type Signer's name _____ Print or type Signer's name

CORPORATE SEAL

EXECUTION OF BID

NON-COLLUSION, DEBARMENT AND GIFT BAN CERTIFICATION

PARTNERSHIP

The bidder, being duly sworn, solemnly swears (or affirms) that neither he, nor any official, agent or employee has entered into any agreement, participated in any collusion, or otherwise taken any action which is in restraint of free competitive bidding in connection with any bid or contract, that the bidder has not been convicted of violating *N.C.G.S. § 133-24* within the last three years, and that the bidder intends to do the work with its own bona fide employees or subcontractors and will not bid for the benefit of another contractor.

By submitting this non-collusion, debarment and gift ban certification, the Contractor is attesting his status under penalty of perjury under the laws of the United States in accordance with the Debarment Certification attached, provided that the Debarment Certification also includes any required statements concerning exceptions that are applicable.

N.C.G.S. § 133-32 and Executive Order 24 prohibit the offer to, or acceptance by, any State Employee of any gift from anyone with a contract with the State, or from any person seeking to do business with the State. By execution of any response in this procurement, you attest, for your entire organization and its employees or agents, that you are not aware that any such gift has been offered, accepted, or promised by any employees of your organization.

SIGNATURE OF PREQUALIFIED BIDDER

Full Name of Partnership

Address as Prequalified

Signature of Witness

Signature of Partner

Print or Type Signer's Name

Print or Type Signer's Name

EXECUTION OF BID

NON-COLLUSION, DEBARMENT AND GIFT BAN CERTIFICATION

LIMITED LIABILITY COMPANY

The bidder, being duly sworn, solemnly swears (or affirms) that neither he, nor any official, agent or employee has entered into any agreement, participated in any collusion, or otherwise taken any action which is in restraint of free competitive bidding in connection with any bid or contract, that the bidder has not been convicted of violating *N.C.G.S. § 133-24* within the last three years, and that the bidder intends to do the work with its own bona fide employees or subcontractors and will not bid for the benefit of another contractor.

By submitting this non-collusion, debarment and gift ban certification, the Contractor is attesting his status under penalty of perjury under the laws of the United States in accordance with the Debarment Certification attached, provided that the Debarment Certification also includes any required statements concerning exceptions that are applicable.

N.C.G.S. § 133-32 and Executive Order 24 prohibit the offer to, or acceptance by, any State Employee of any gift from anyone with a contract with the State, or from any person seeking to do business with the State. By execution of any response in this procurement, you attest, for your entire organization and its employees or agents, that you are not aware that any such gift has been offered, accepted, or promised by any employees of your organization.

SIGNATURE OF PREQUALIFIED BIDDER

Full Name of Firm

Address as Prequalified

Signature of Witness

Signature of Member/Manager/Authorized Agent
(Select appropriate Title)

Print or Type Signer's Name

Print or Type Signer's Name

**EXECUTION OF BID
NON-COLLUSION, DEBARMENT AND GIFT BAN CERTIFICATION**

JOINT VENTURE (2) or (3)

The bidder, being duly sworn, solemnly swears (or affirms) that neither he, nor any official, agent or employee has entered into any agreement, participated in any collusion, or otherwise taken any action which is in restraint of free competitive bidding in connection with any bid or contract, that the bidder has not been convicted of violating *N.C.G.S. § 133-24* within the last three years, and that the bidder intends to do the work with its own bona fide employees or subcontractors and will not bid for the benefit of another contractor.

By submitting this non-collusion, debarment and gift ban certification, the Contractor is attesting his status under penalty of perjury under the laws of the United States in accordance with the Debarment Certification attached, provided that the Debarment Certification also includes any required statements concerning exceptions that are applicable.

N.C.G.S. § 133-32 and Executive Order 24 prohibit the offer to, or acceptance by, any State Employee of any gift from anyone with a contract with the State, or from any person seeking to do business with the State. By execution of any response in this procurement, you attest, for your entire organization and its employees or agents, that you are not aware that any such gift has been offered, accepted, or promised by any employees of your organization.

SIGNATURE OF PREQUALIFIED BIDDER

Instructions: **2 Joint Venturers** Fill in lines (1), (2) and (3) and execute. **3 Joint Venturers** Fill in lines (1), (2), (3) and (4) and execute. On Line (1), fill in the name of the Joint Venture Company. On Line (2), fill in the name of one of the joint venturers and execute below in the appropriate manner. On Line (3), print or type the name of the other joint venturer and execute below in the appropriate manner. On Line (4), fill in the name of the third joint venturer, if applicable and execute below in the appropriate manner.

(1) _____
Name of Joint Venture

(2) _____
Name of Contractor

Address as Prequalified

BY

Signature of Witness or Attest _____ Signature of Contractor _____

Print or Type Signer's Name _____ Print or Type Signer's Name _____

If Corporation, affix Corporate Seal AND

(3) _____
Name of Contractor

Address as Prequalified

BY

Signature of Witness or Attest _____ Signature of Contractor _____

Print or Type Signer's Name _____ Print or Type Signer's Name _____

If Corporation, affix Corporate Seal AND

(4) _____
Name of Contractor

Address as Prequalified

BY

Signature of Witness or Attest _____ Signature of Contractor _____

Print or Type Signer's Name _____ Print or Type Signer's Name _____

If Corporation, affix Corporate Seal

EXECUTION OF BID

NON-COLLUSION, DEBARMENT AND GIFT BAN CERTIFICATION

INDIVIDUAL DOING BUSINESS UNDER A FIRM NAME

The bidder, being duly sworn, solemnly swears (or affirms) that neither he, nor any official, agent or employee has entered into any agreement, participated in any collusion, or otherwise taken any action which is in restraint of free competitive bidding in connection with any bid or contract, that the bidder has not been convicted of violating *N.C.G.S. § 133-24* within the last three years, and that the bidder intends to do the work with its own bona fide employees or subcontractors and will not bid for the benefit of another contractor.

By submitting this non-collusion, debarment and gift ban certification, the Contractor is attesting his status under penalty of perjury under the laws of the United States in accordance with the Debarment Certification attached, provided that the Debarment Certification also includes any required statements concerning exceptions that are applicable.

N.C.G.S. § 133-32 and Executive Order 24 prohibit the offer to, or acceptance by, any State Employee of any gift from anyone with a contract with the State, or from any person seeking to do business with the State. By execution of any response in this procurement, you attest, for your entire organization and its employees or agents, that you are not aware that any such gift has been offered, accepted, or promised by any employees of your organization.

SIGNATURE OF PREQUALIFIED BIDDER

Name of Bidder

Individual Name

Trading and Doing Business As

Full name of Firm

Address as Prequalified

Signature of Witness

Signature of Bidder, Individual

Print or Type Signer's Name

Print or Type Signer's Name

EXECUTION OF BID

NON-COLLUSION, DEBARMENT AND GIFT BAN CERTIFICATION

INDIVIDUAL DOING BUSINESS IN HIS OWN NAME

The bidder, being duly sworn, solemnly swears (or affirms) that neither he, nor any official, agent or employee has entered into any agreement, participated in any collusion, or otherwise taken any action which is in restraint of free competitive bidding in connection with any bid or contract, that the bidder has not been convicted of violating *N.C.G.S. § 133-24* within the last three years, and that the bidder intends to do the work with its own bona fide employees or subcontractors and will not bid for the benefit of another contractor.

By submitting this non-collusion, debarment and gift ban certification, the Contractor is attesting his status under penalty of perjury under the laws of the United States in accordance with the Debarment Certification attached, provided that the Debarment Certification also includes any required statements concerning exceptions that are applicable.

N.C.G.S. § 133-32 and Executive Order 24 prohibit the offer to, or acceptance by, any State Employee of any gift from anyone with a contract with the State, or from any person seeking to do business with the State. By execution of any response in this procurement, you attest, for your entire organization and its employees or agents, that you are not aware that any such gift has been offered, accepted, or promised by any employees of your organization.

SIGNATURE OF PREQUALIFIED BIDDER

Name of Bidder

Print or Type Name

Address as Prequalified

Signature of Bidder, Individually

Print or type Signer's Name

Signature of Witness

Print or type Signer's name

DEBARMENT CERTIFICATION OF PREQUALIFIED BIDDER

Conditions for certification:

1. The prequalified bidder shall provide immediate written notice to the Department if at any time the bidder learns that his certification was erroneous when he submitted his debarment certification or explanation that is file with the Department, or has become erroneous because of changed circumstances.
2. The terms *covered transaction*, *debarred*, *suspended*, *ineligible*, *lower tier covered transaction*, *participant*, *person*, *primary covered transaction*, *principal*, *proposal*, and *voluntarily excluded*, as used in this provision, have the meanings set out in the Definitions and Coverage sections of the rules implementing Executive Order 12549. A copy of the Federal Rules requiring this certification and detailing the definitions and coverages may be obtained from the Contract Officer of the Department.
3. The prequalified bidder agrees by submitting this form that he will not knowingly enter into any lower tier covered transaction with a person who is debarred, suspended, declared ineligible, or voluntarily excluded from participation in NCDOT contracts, unless authorized by the Department.
4. For Federal Aid projects, the prequalified bidder further agrees that by submitting this form he will include the Federal-Aid Provision titled *Required Contract Provisions Federal-Aid Construction Contract (Form FHWA PR 1273)* provided by the Department, without subsequent modification, in all lower tier covered transactions.
5. The prequalified bidder may rely upon a certification of a participant in a lower tier covered transaction that he is not debarred, suspended, ineligible, or voluntarily excluded from the covered transaction, unless he knows that the certification is erroneous. The bidder may decide the method and frequency by which he will determine the eligibility of his subcontractors.
6. Nothing contained in the foregoing shall be construed to require establishment of a system of records in order to render in good faith the certification required by this provision. The knowledge and information of a participant is not required to exceed that which is normally possessed by a prudent person in the ordinary course of business dealings.
7. Except as authorized in paragraph 6 herein, the Department may terminate any contract if the bidder knowingly enters into a lower tier covered transaction with a person who is suspended, debarred, ineligible, or voluntarily excluded from participation in this transaction, in addition to other remedies available by the Federal Government.

DEBARMENT CERTIFICATION

The prequalified bidder certifies to the best of his knowledge and belief, that he and his principals:

- a. Are not presently debarred, suspended, proposed for debarment, declared ineligible, or voluntarily excluded from covered transactions by any Federal department or agency;
- b. Have not within a three-year period preceding this proposal been convicted of or had a civil judgment rendered against them for commission of fraud or a criminal offense in connection with obtaining, attempting to obtain, or performing a public (Federal, State or local) transaction or contract under a public transaction; violation of Federal or State antitrust statutes or commission of embezzlement, theft, forgery, bribery, falsification or destruction of records; making false statements; or receiving stolen property;
- c. Are not presently indicted for or otherwise criminally or civilly charged by a governmental entity (Federal, State or local) with commission of any of the offenses enumerated in paragraph b. of this certification; and
- d. Have not within a three-year period preceding this proposal had one or more public transactions (Federal, State or local) terminated for cause or default.
- e. Will submit a revised Debarment Certification immediately if his status changes and will show in his bid proposal an explanation for the change in status.

If the prequalified bidder cannot certify that he is not debarred, he shall provide an explanation with this submittal. An explanation will not necessarily result in denial of participation in a contract.

Failure to submit a non-collusion affidavit and debarment certification will result in the bidder's bid being considered non-responsive.

Check here if an explanation is attached to this certification.

BID SUBMITTAL PACKAGE CHECKLIST

This checklist has been provided for your benefit to assist you in completing your Bid Submittal Package to help ensure that all necessary items have been completed.

Check Box	Page Number	Description
	1	Cover Sheet.
	2	Contract Bid Form.
	3	Contractor’s Information.
	4	Federal Employer Identification Number
	5	Listing of MBE/WBE Subcontractors.
	6	Contractor’s Work Experience and References, with a minimum of three (3) references included.
	7-14	Execution of Bid Non-Collusion Affidavit, Debarment Certification and Gift Ban Certification, executed.
	15	Bid Submittal Package Checklist
		Addenda, if applicable.
		Submit original and one (1) duplicate copy.
		Mark the original as “Original” and the copy as “Copy”.

**YOU MUST BE PRE-QUALIFIED TO BID AS EITHER A BIDDER OR POC PRIME CONTRACTOR!
SEE PROJECT SPECIAL PROVISIONS FOR FURTHER INSTRUCTIONS.**

End of bid submittal package!